

Booklet available in English on
Heft in deutscher Sprache erhältlich auf
Livret disponible en français sur
Libretto disponibile in italiano su
Folleto en español disponible en
如需中文版手册, 请访问

[LEGO.com/service/buildinginstructions](https://www.lego.com/service/buildinginstructions)





[LEGO.com/sustainable-packaging](https://www.lego.com/sustainable-packaging)



IDEAS



LEGO® Ideas Grand Prize Winner

Jessica Kiaei

Jessica Kiaei (LEGO® Ideas name Firecracker_) still has fond memories of school trips to the local science museum and was inspired by its Air & Space exhibit for this set:

'When LEGO Ideas announced the *Ready, Set, Go STEM!* contest, I wanted to pay tribute to Galileo Galilei and celebrate his contributions to science, in LEGO form! As a kid, I used LEGO bricks as a playground for my imagination, a way to explore new and exciting worlds. Now that my life is busier, it's a way to relax and reconnect with my childhood. My work is all digital, so it feels rewarding to step away from the computer, build a new set and improve my skills as an artist and storyteller. Becoming a LEGO designer has been a lifelong dream, and it's exciting to be a small part of LEGO history! I hope everyone enjoys building the set and finding nods to Galileo's discoveries in his office.'

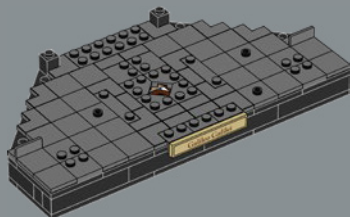

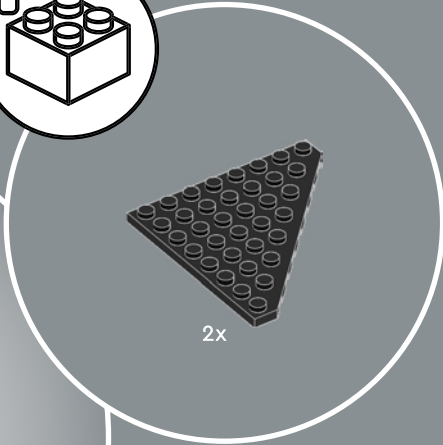
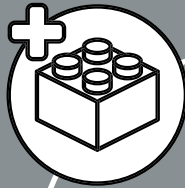



1

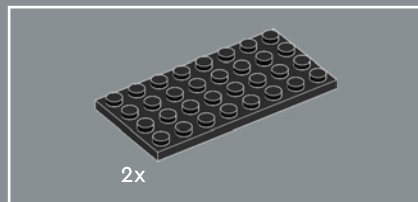
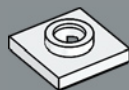

2

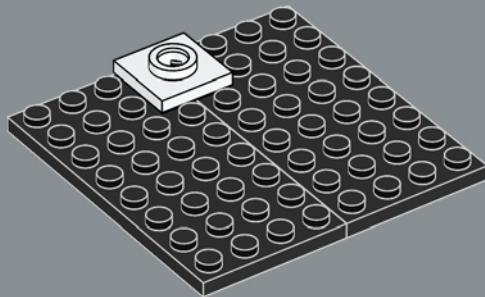

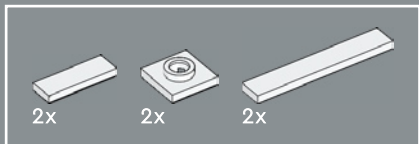

3

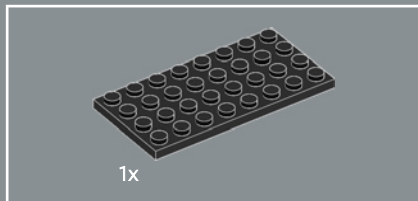
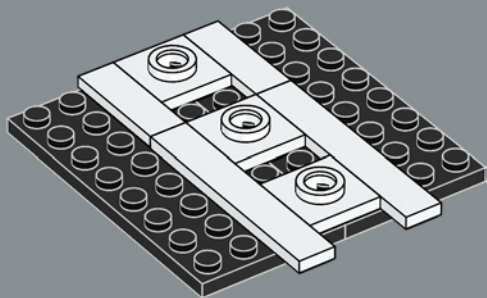

4

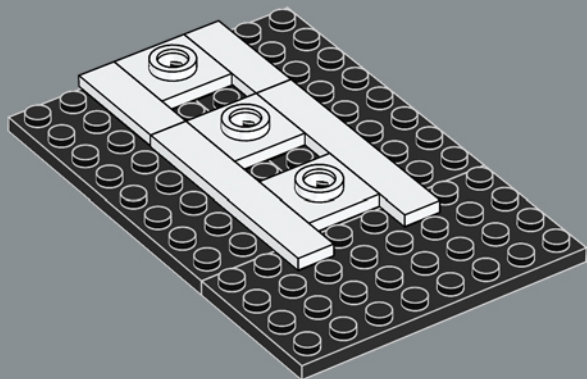



5

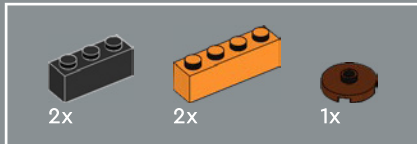
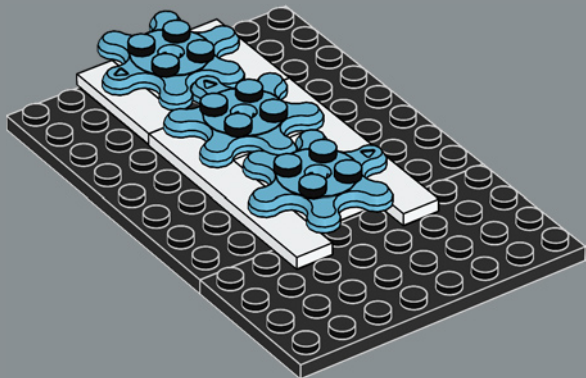

6

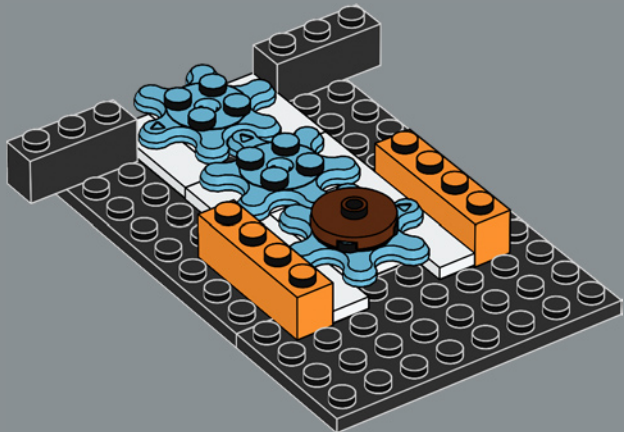

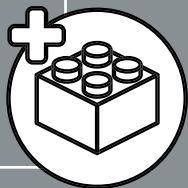
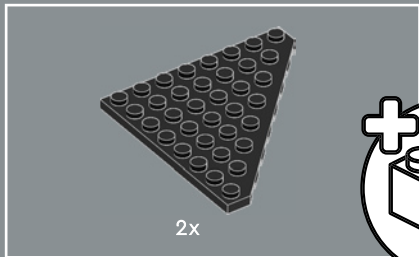

7

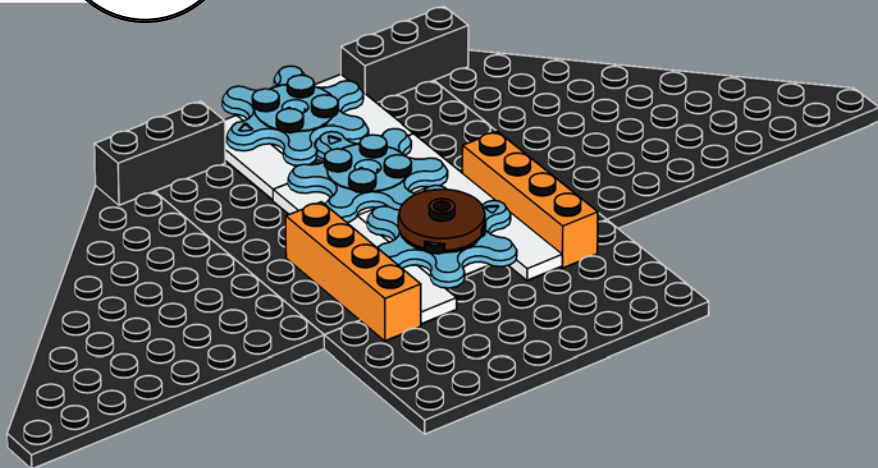

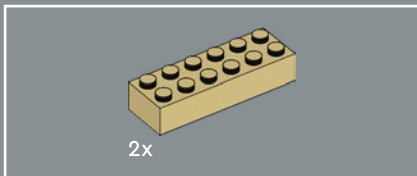

8

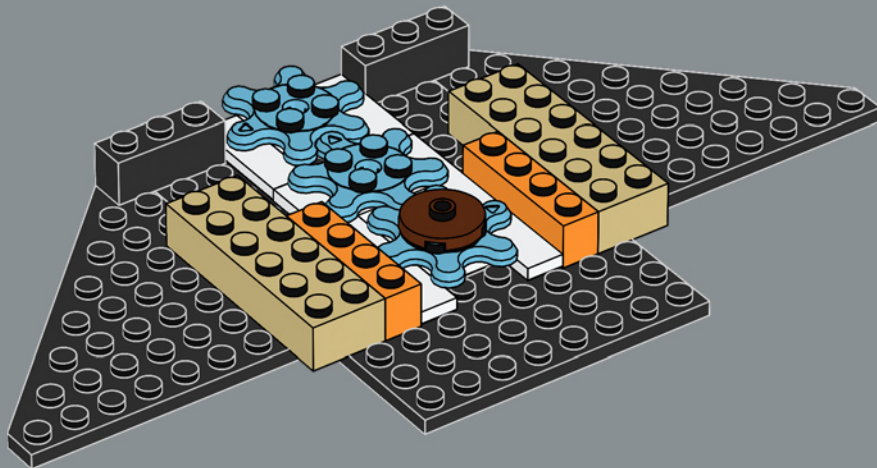

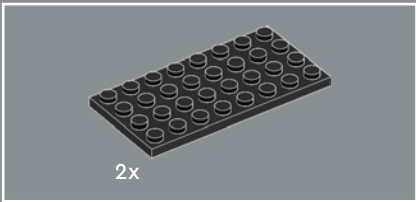

9

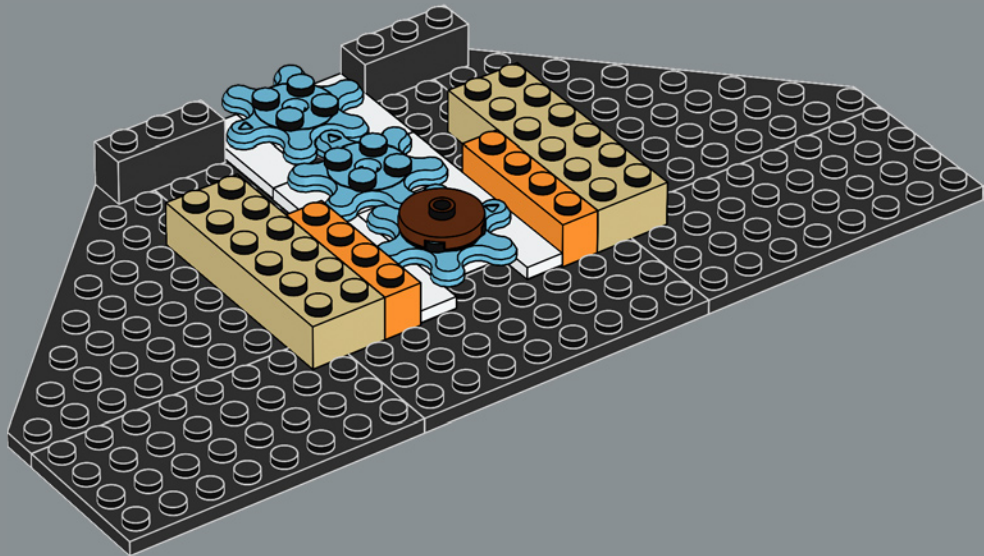



2x



4x

10

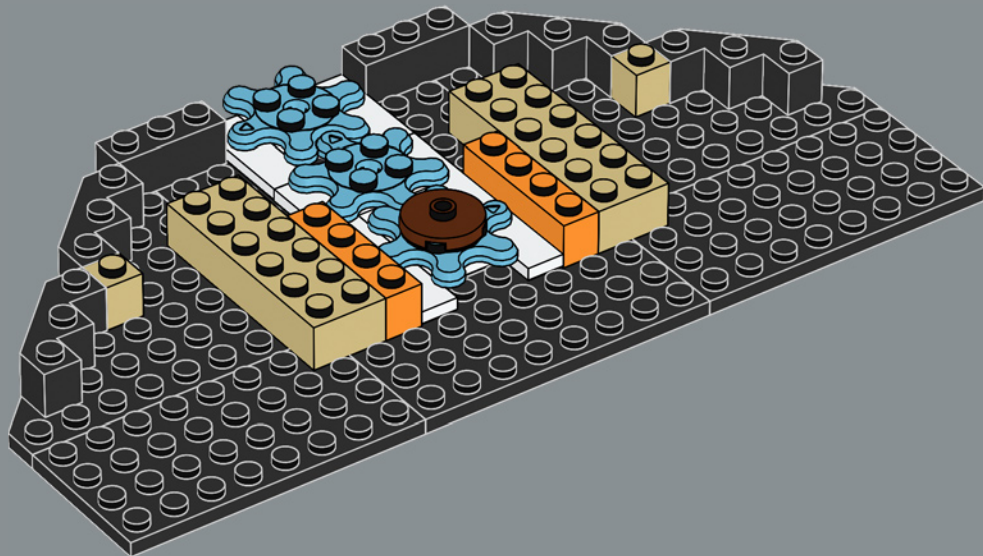

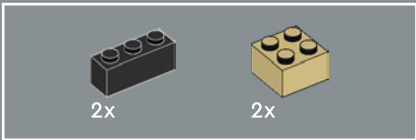

11

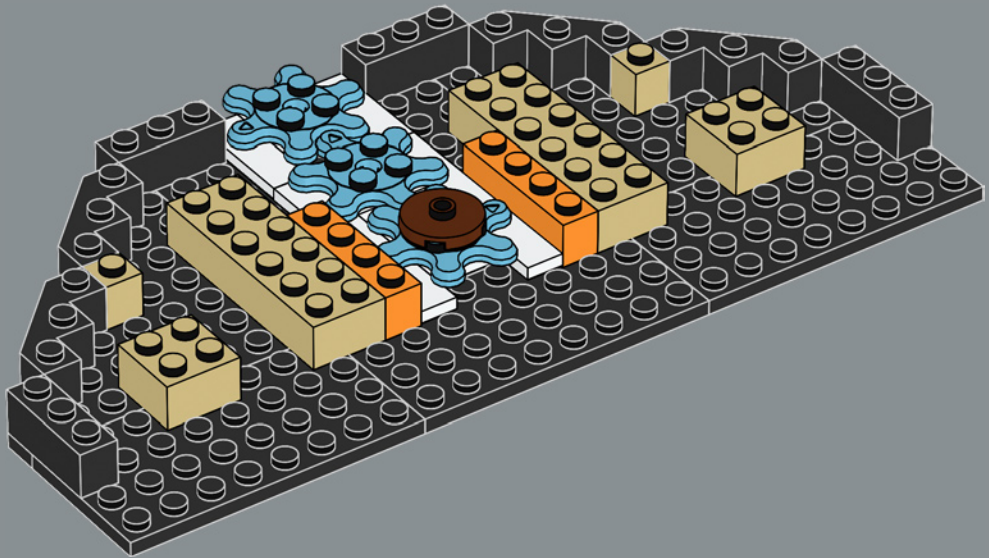

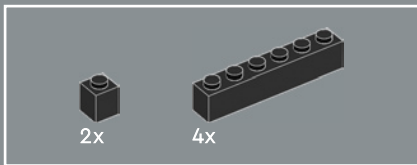

12

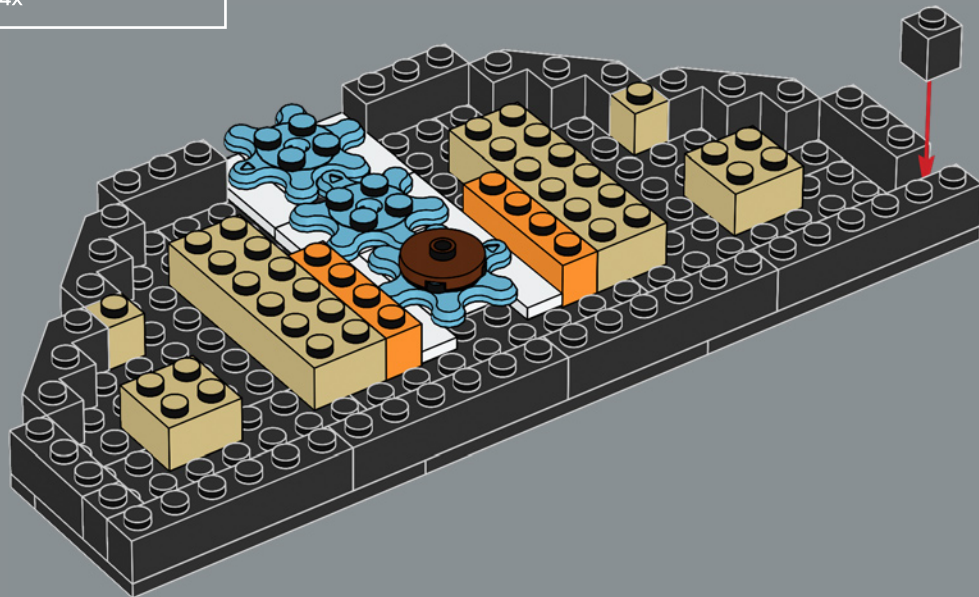

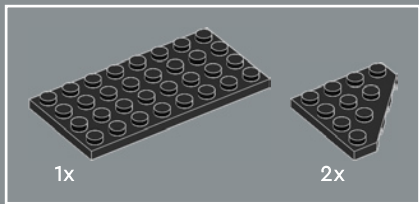

13

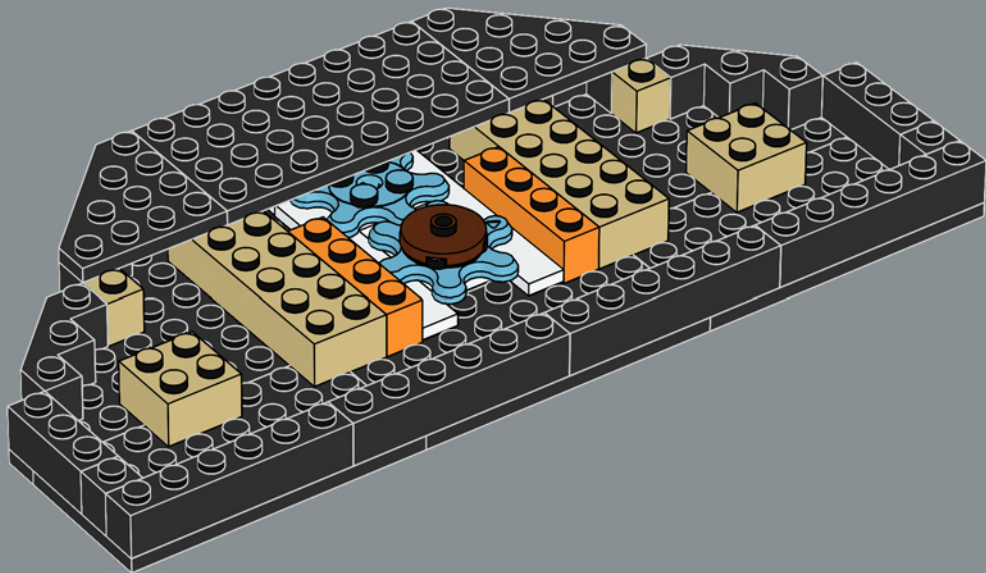

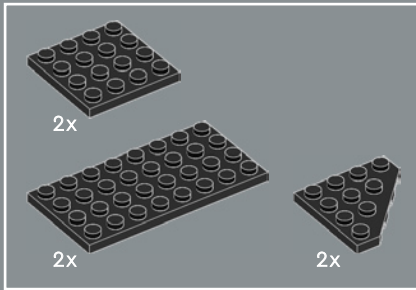

14

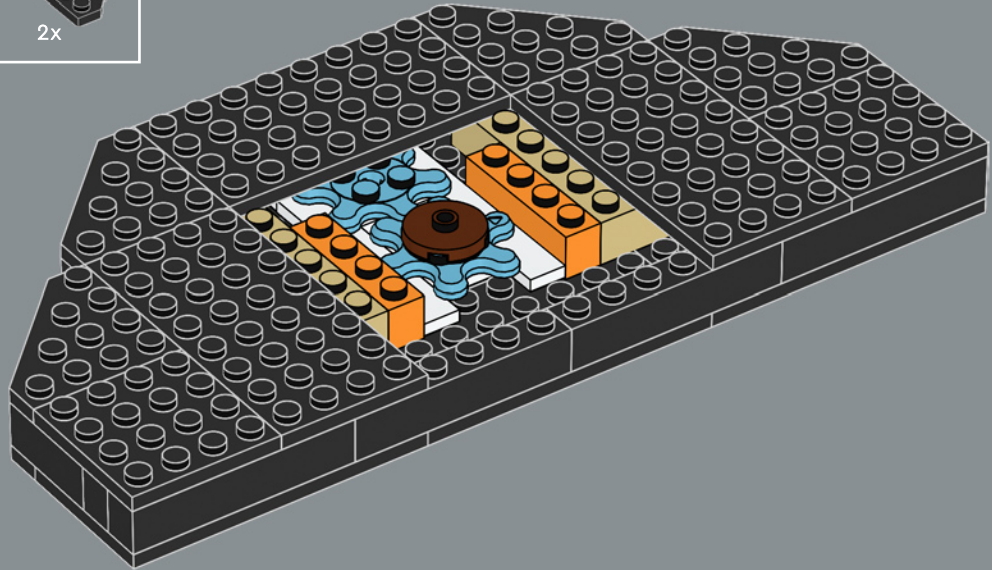

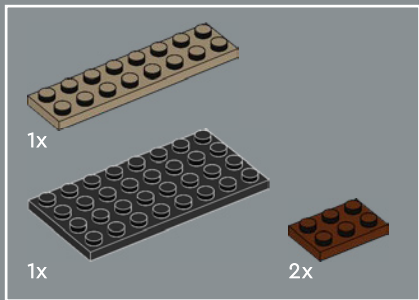

15

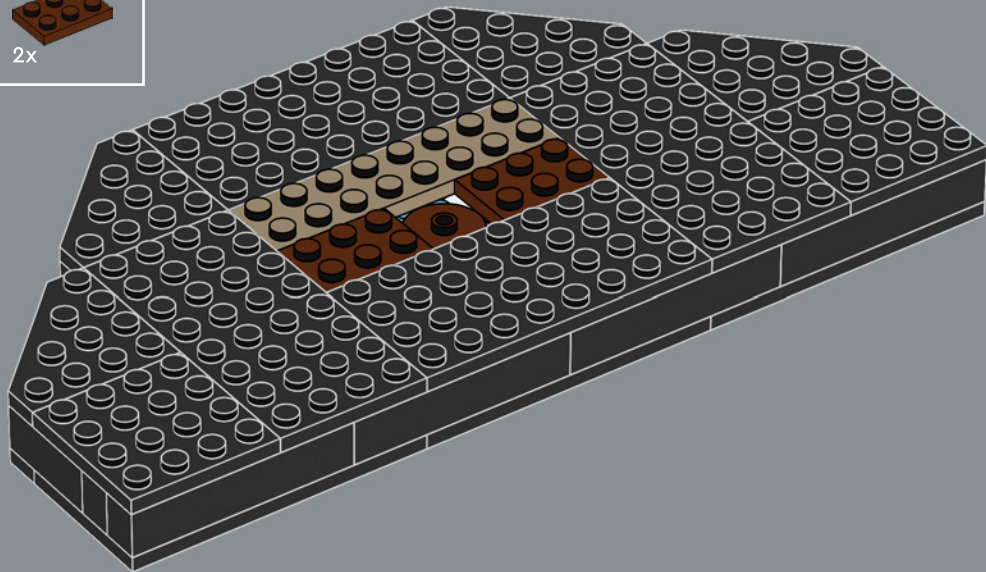

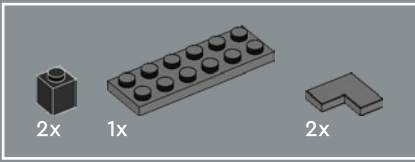

16

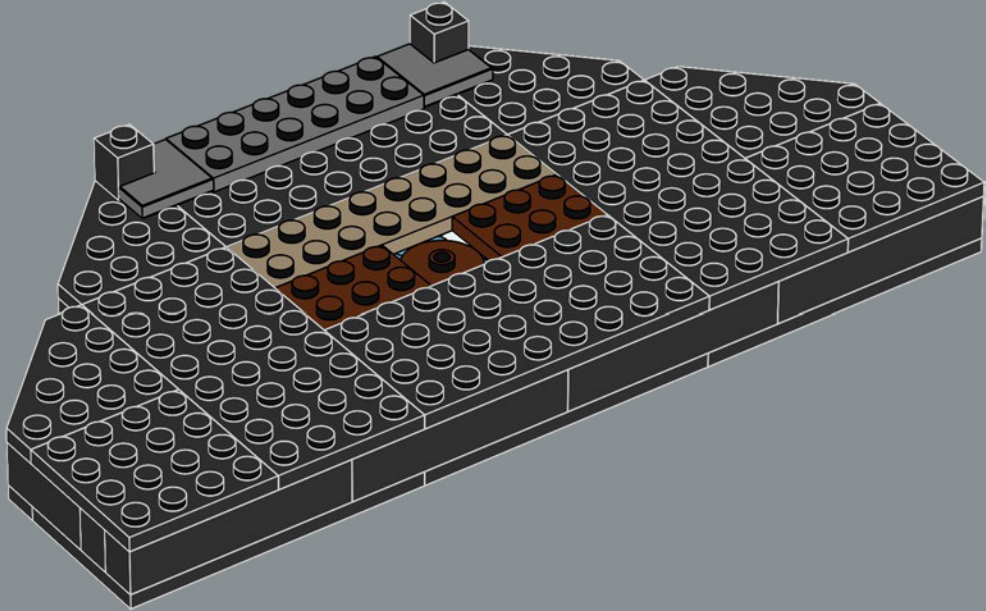

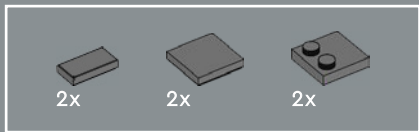

17

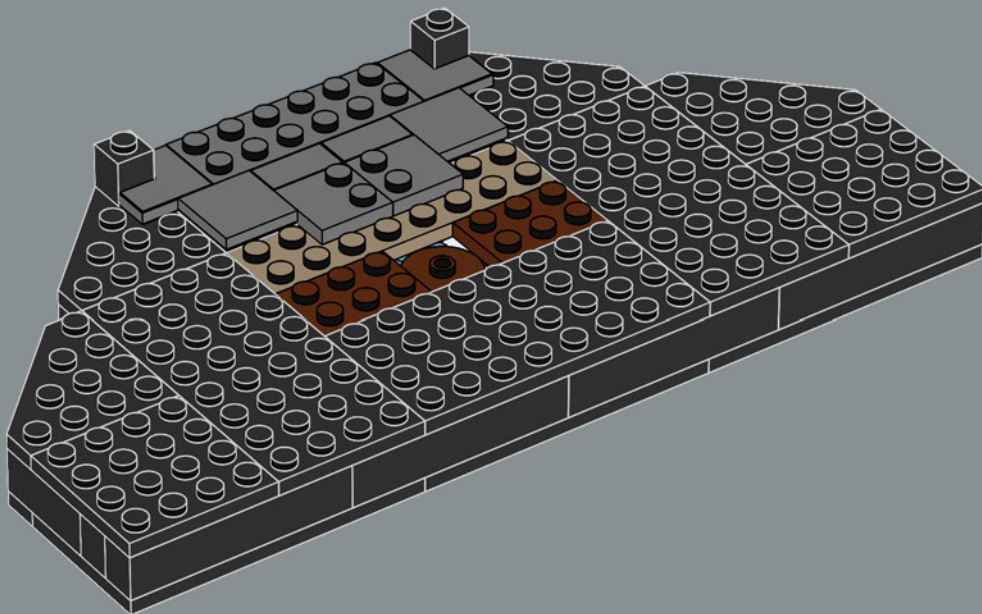



4x



2x

18

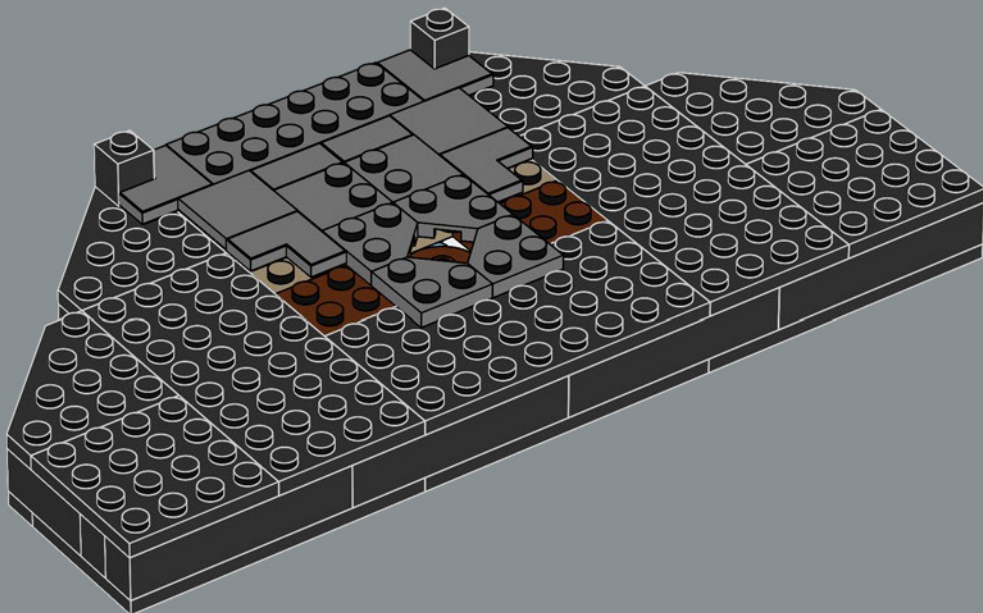

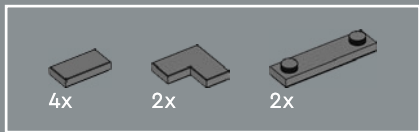

19

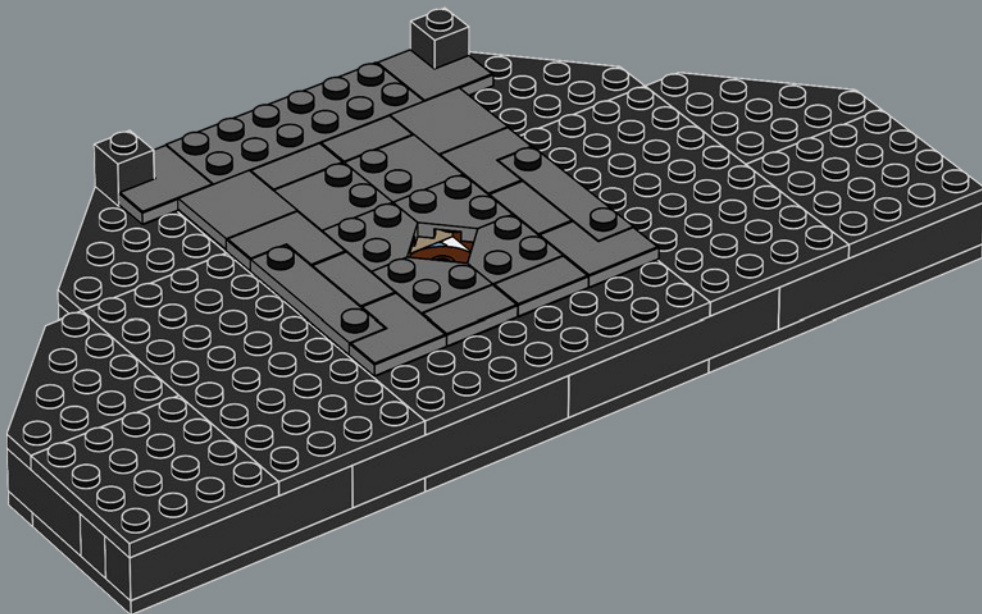

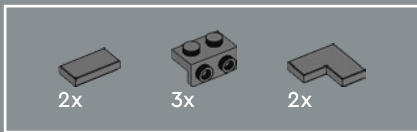

20

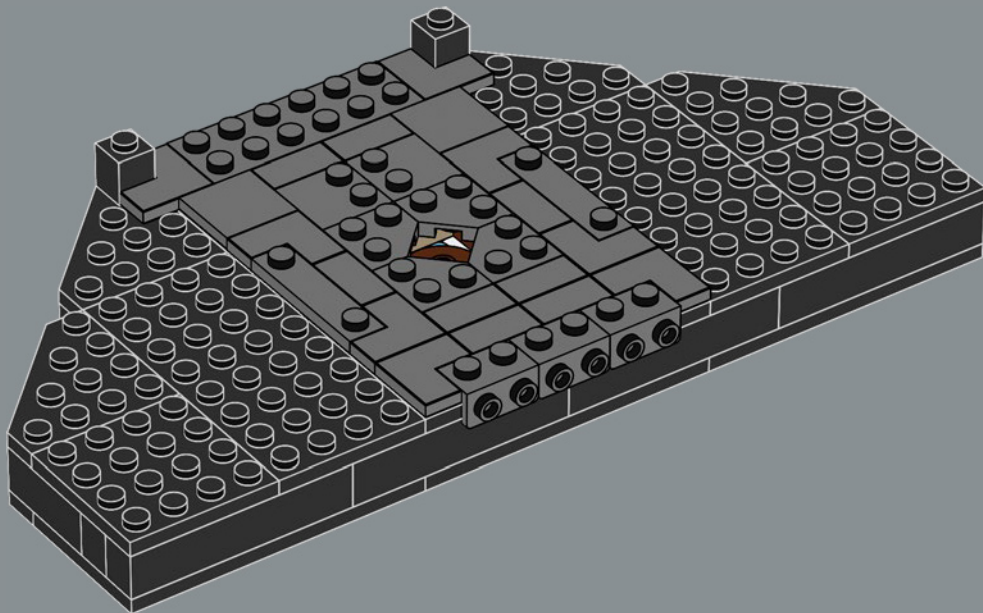

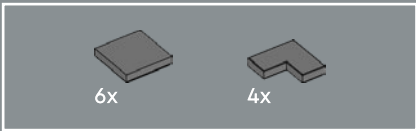

21

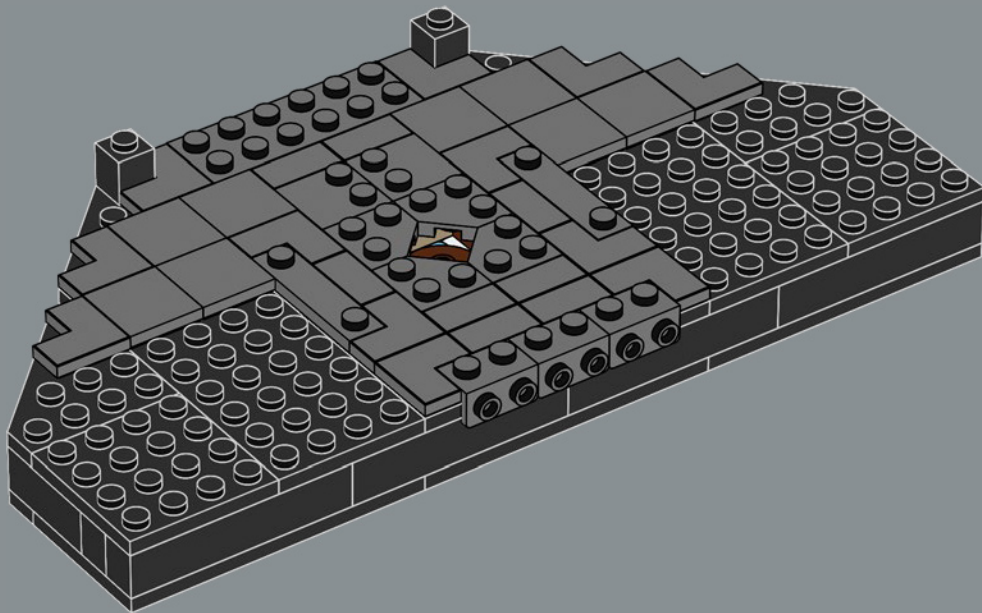

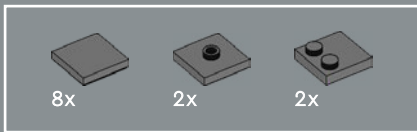

22

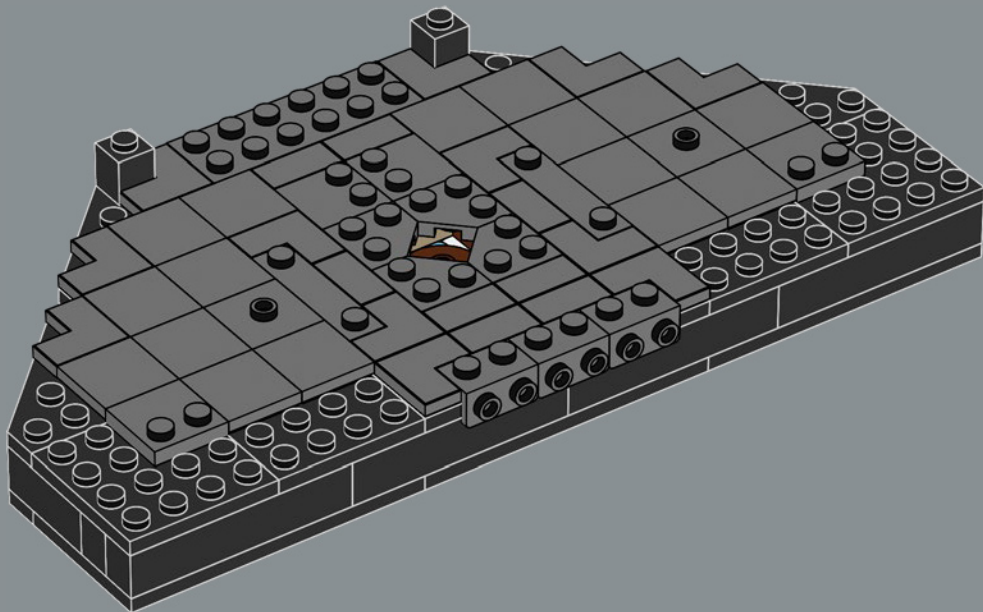

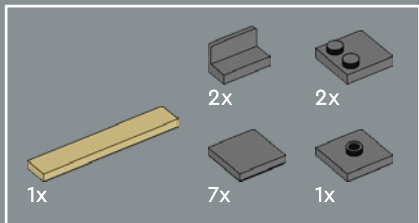

23

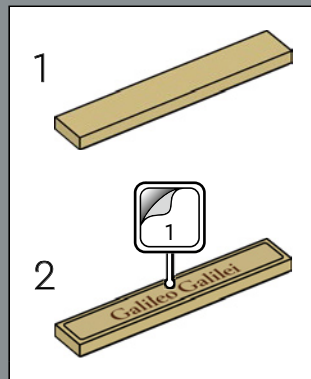
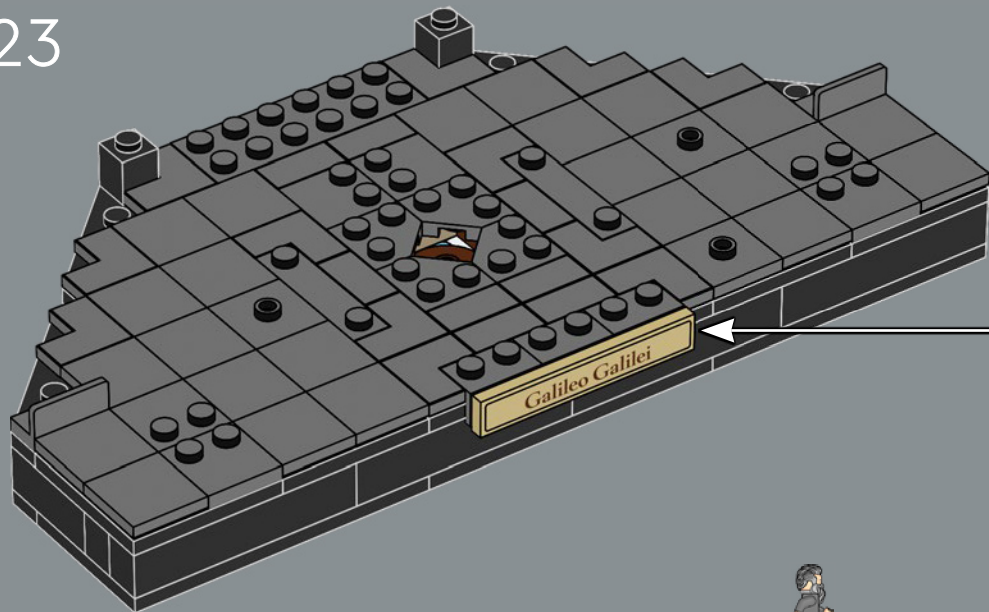

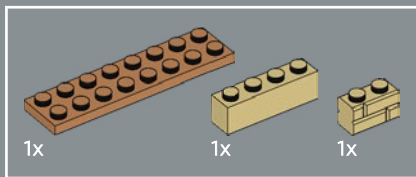
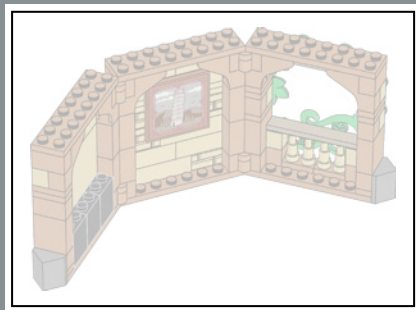

24

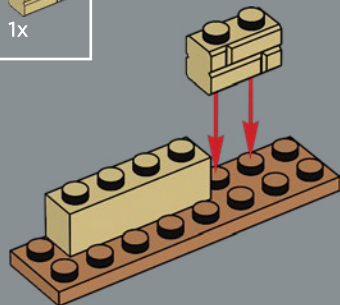

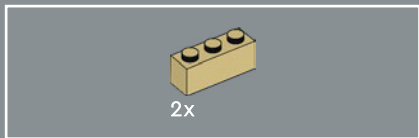

25

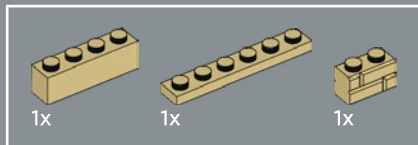
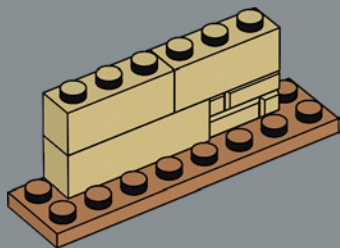

26

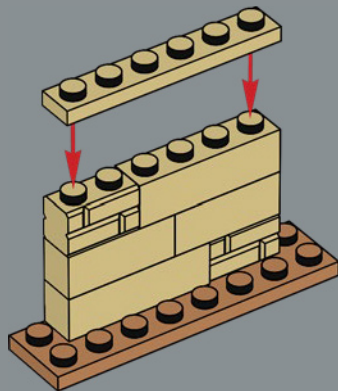

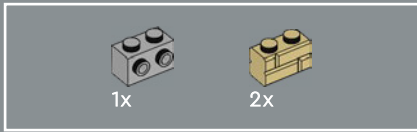

27

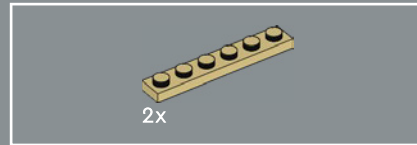
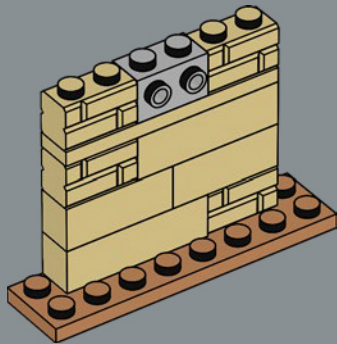

28

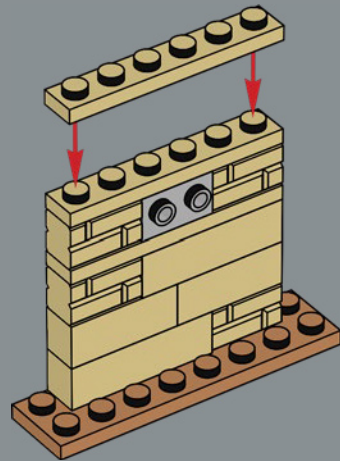



1x

29

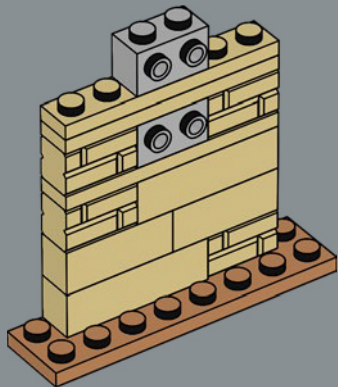

30



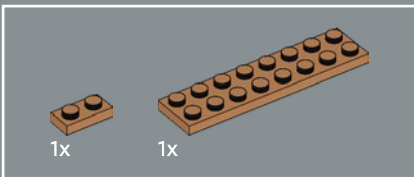
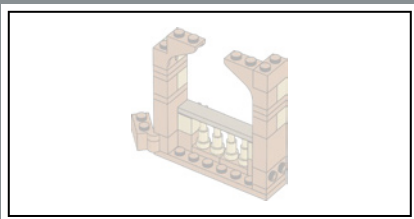

30

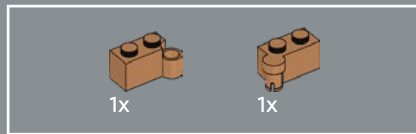
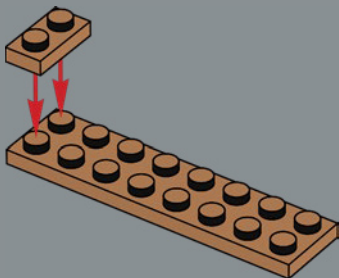

31

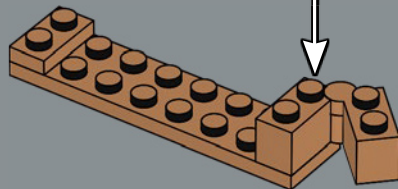
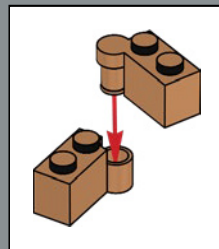



2x



2x

32

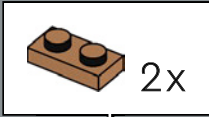

2x

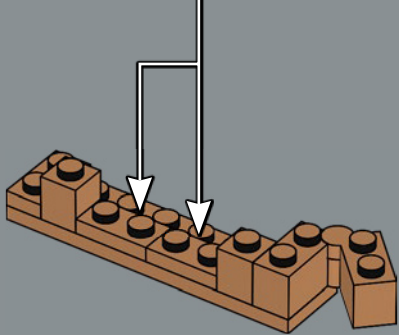

2x



4x

33

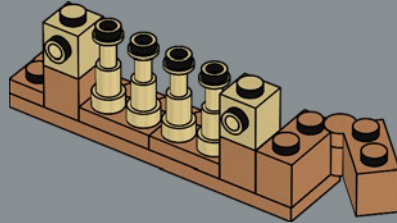

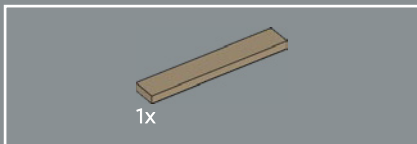

34

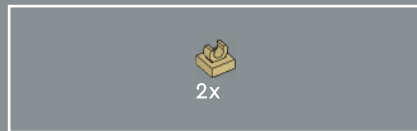
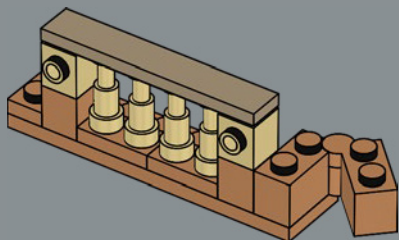

35

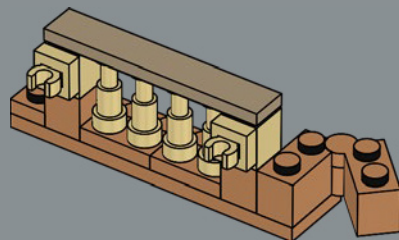

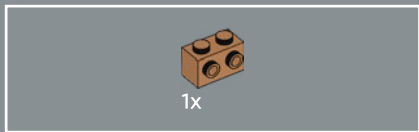

36

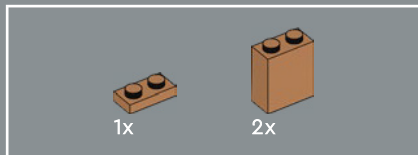
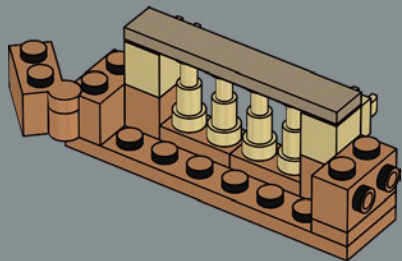

37

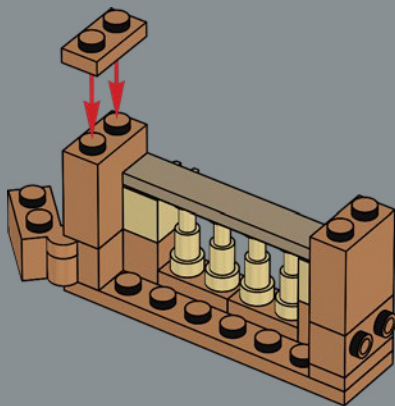



2x



2x

38

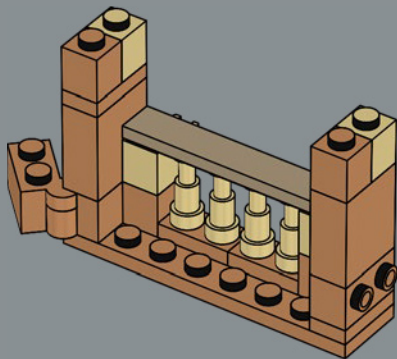

4x

39

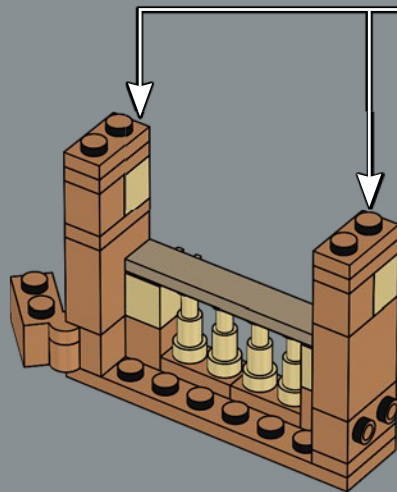

2x



2x

40

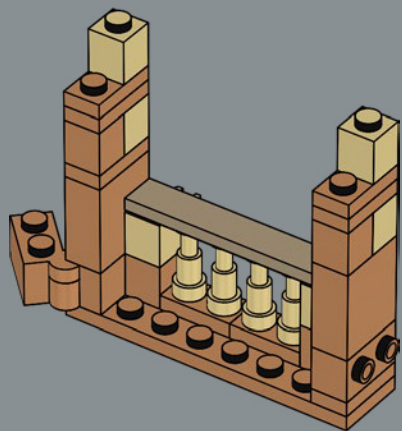

2x

41

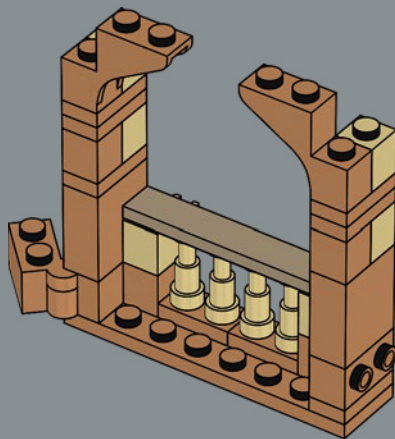

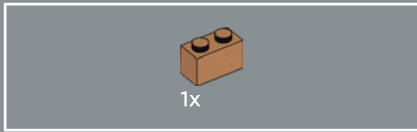

42

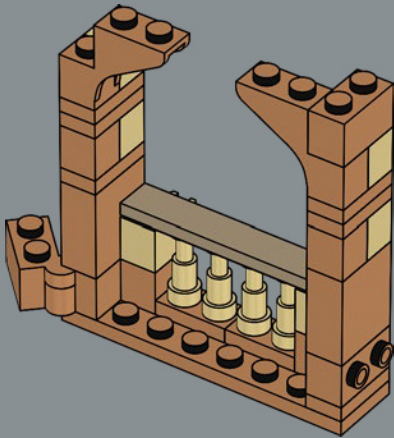

43

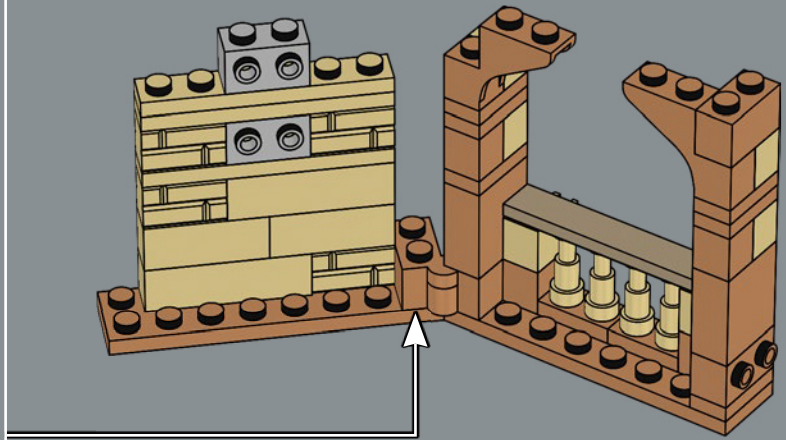

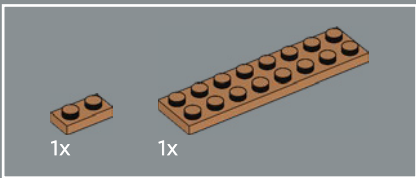
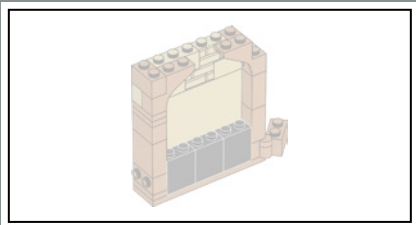

44

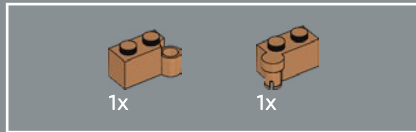
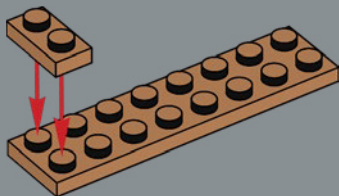

45

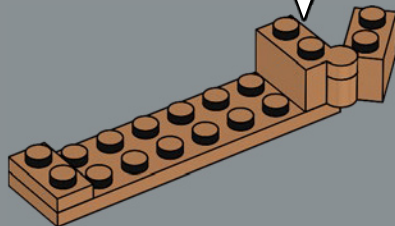
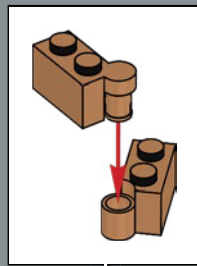

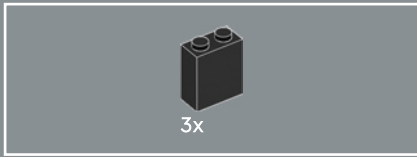

46

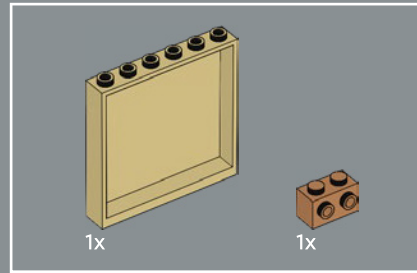
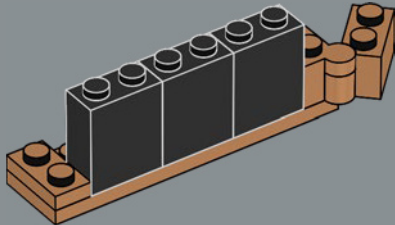

47

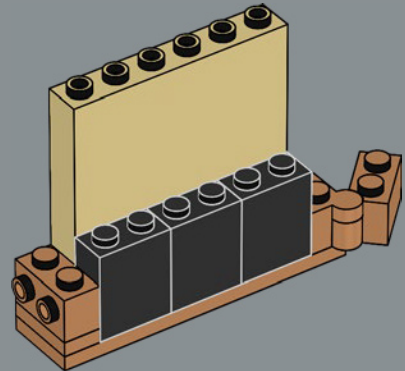

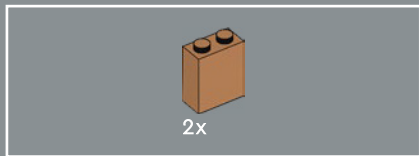

48

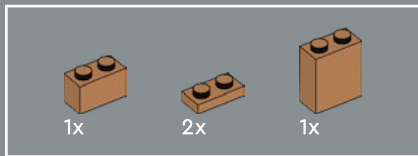
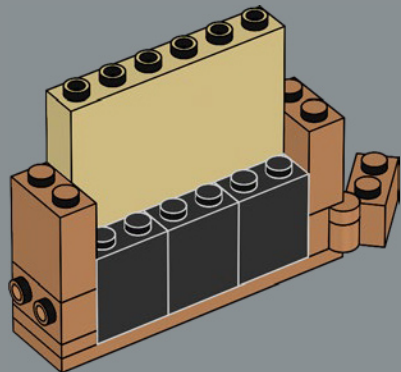

49

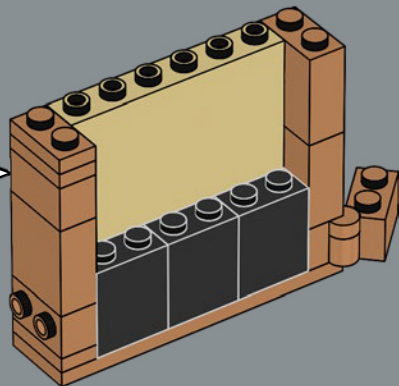
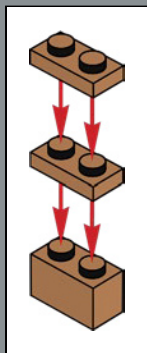

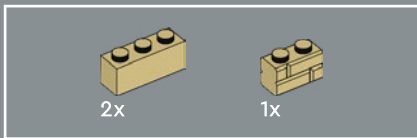

50

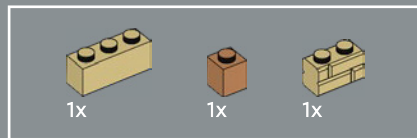
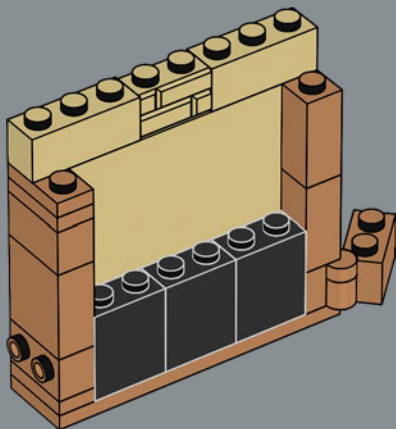

51

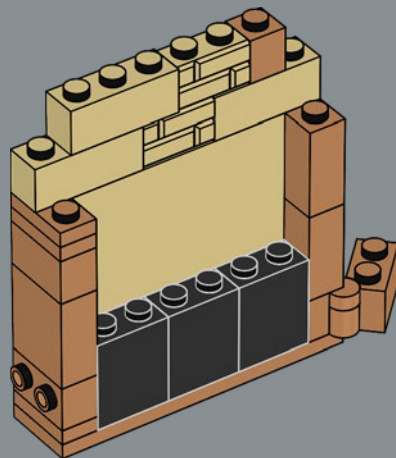

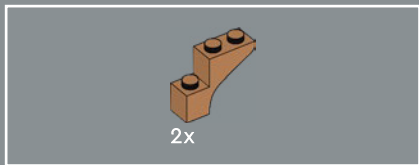

52

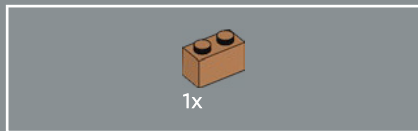
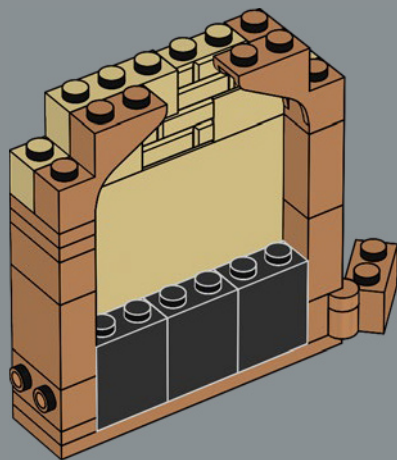

53

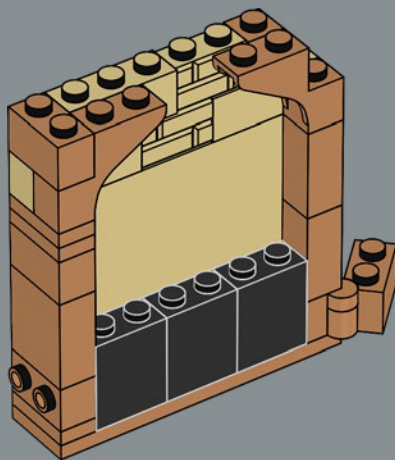

54

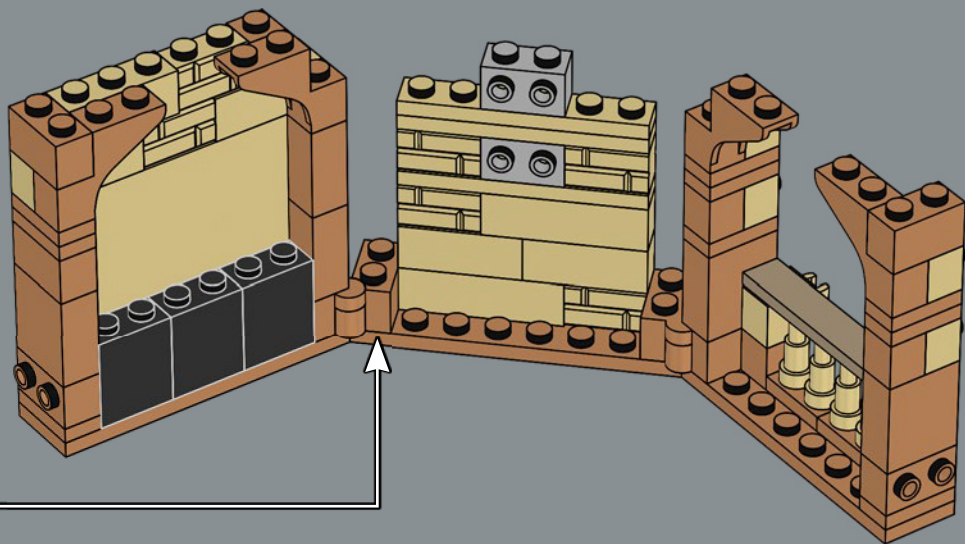

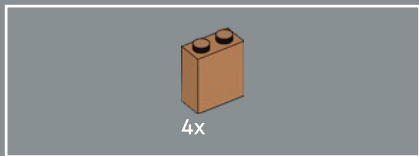

55

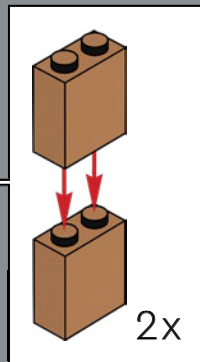
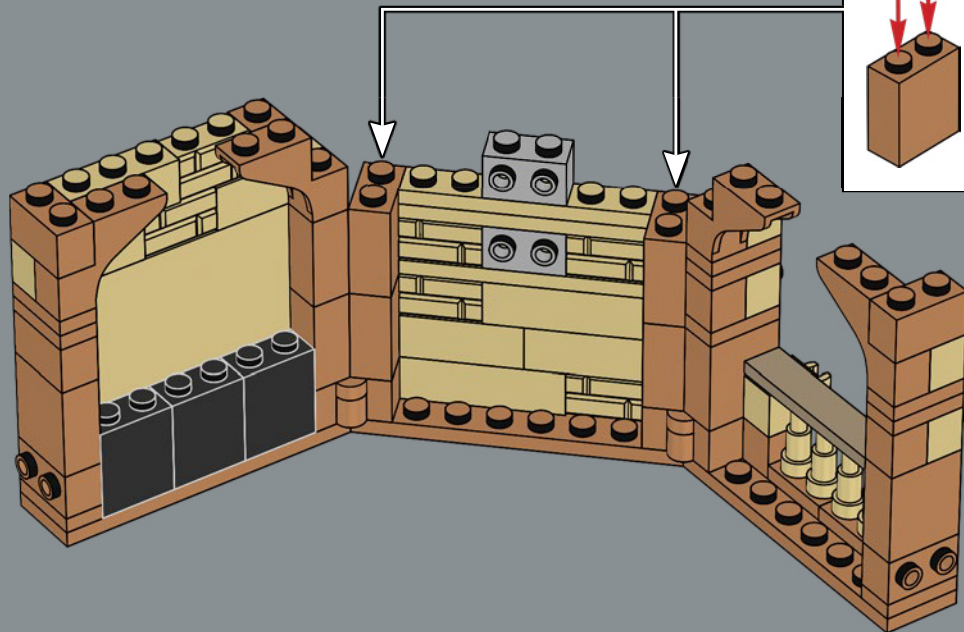

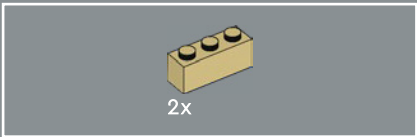

56

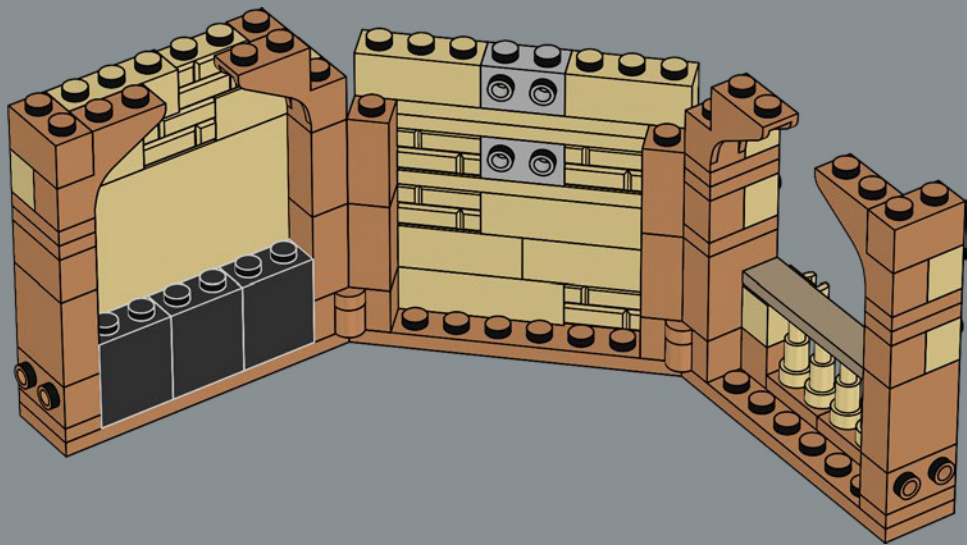

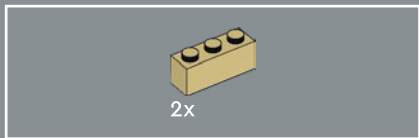

57

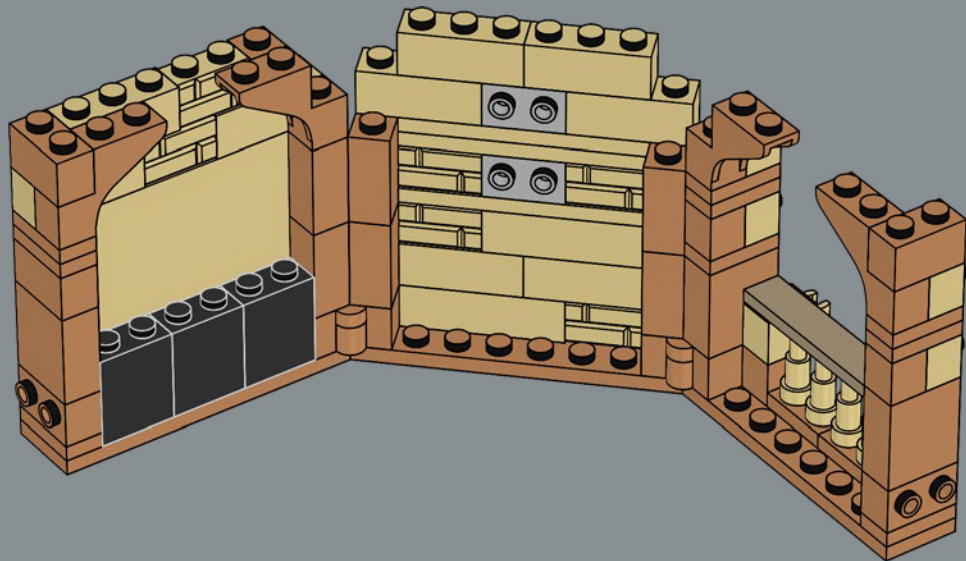

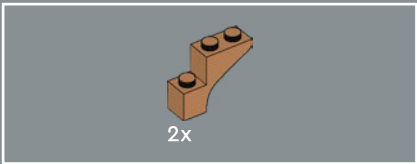

58

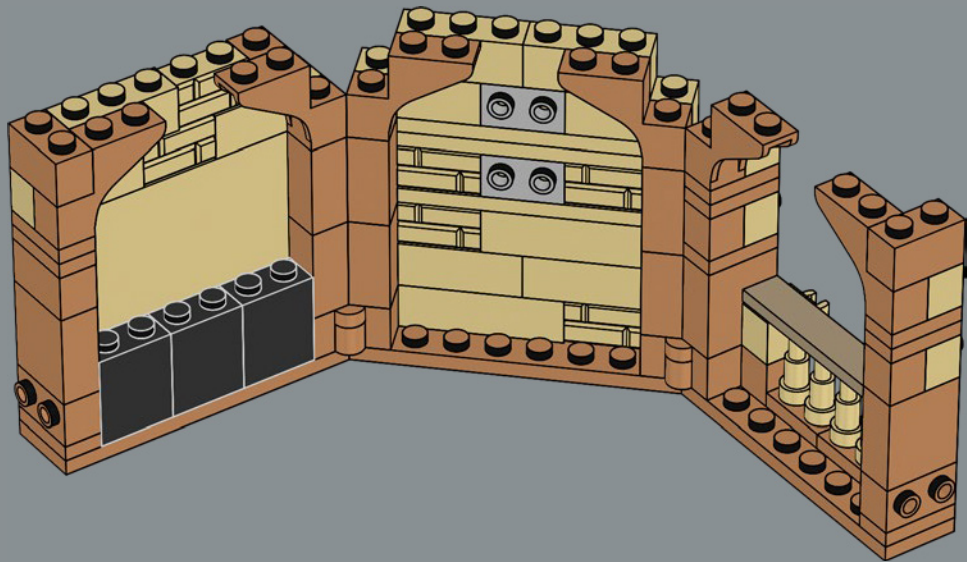

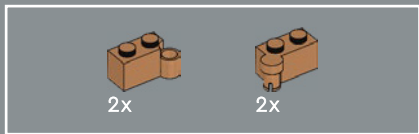

59

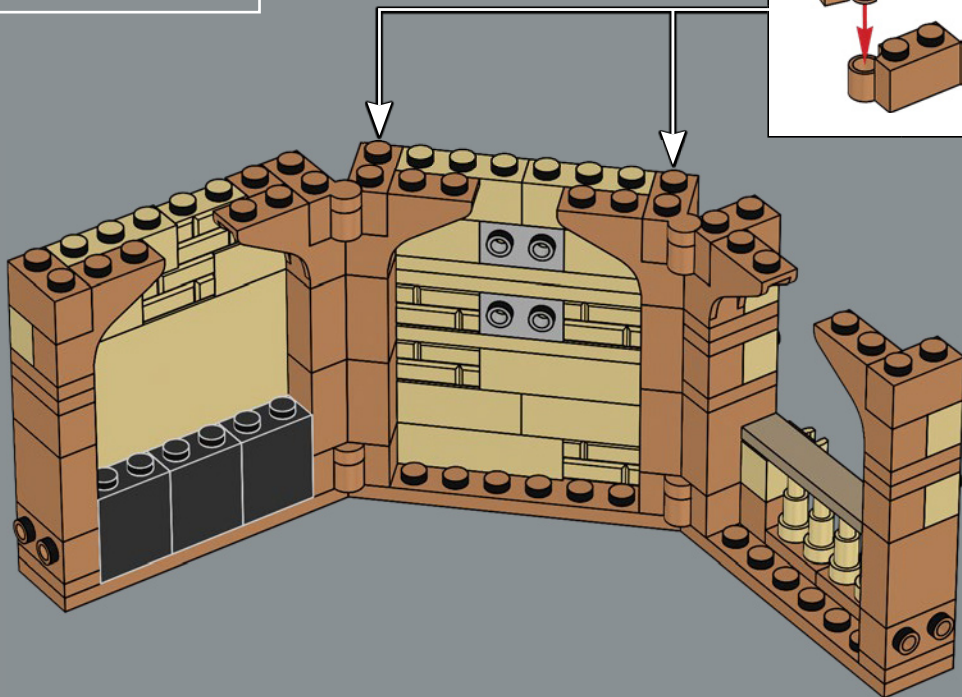
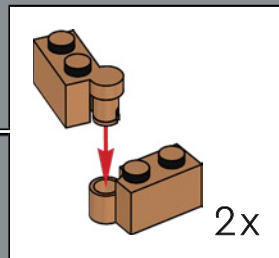

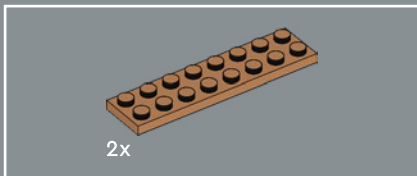

60

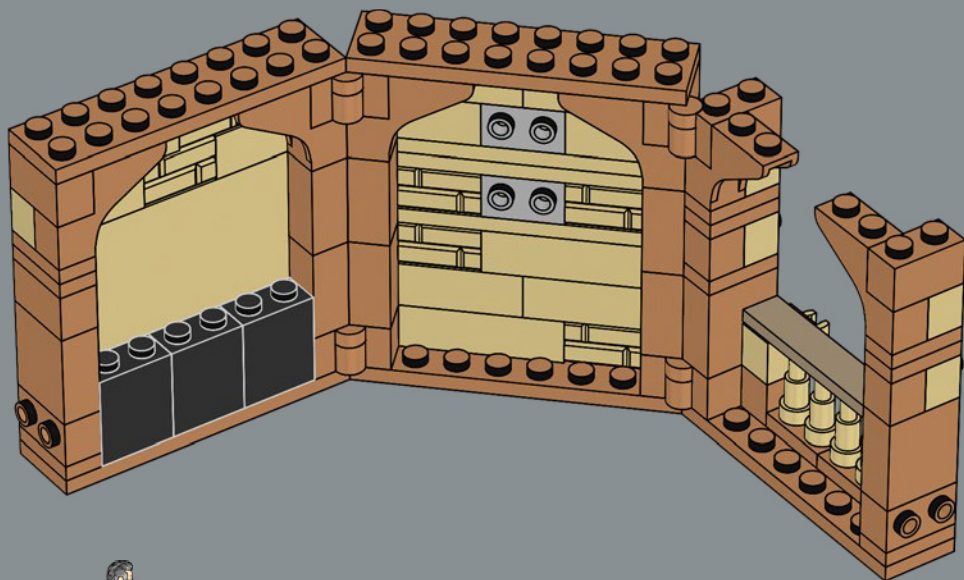

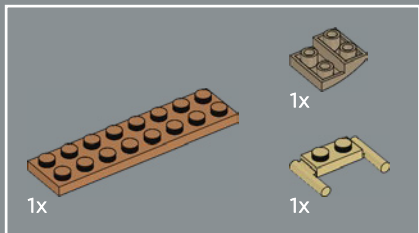

61

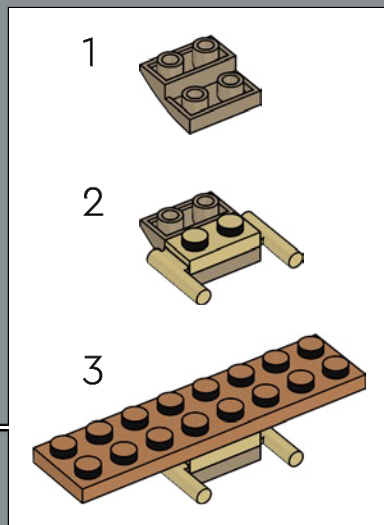
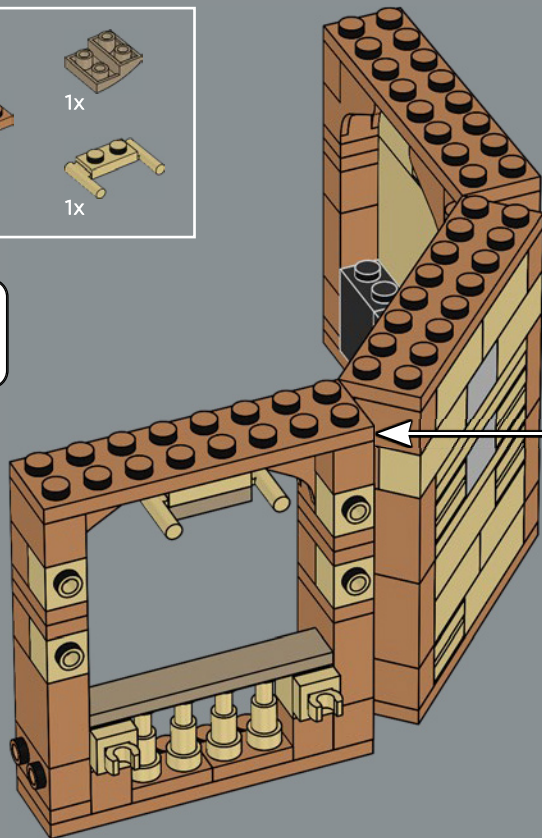

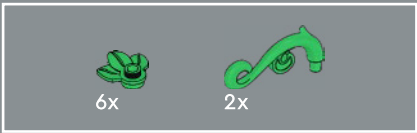

62



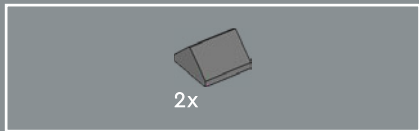

63

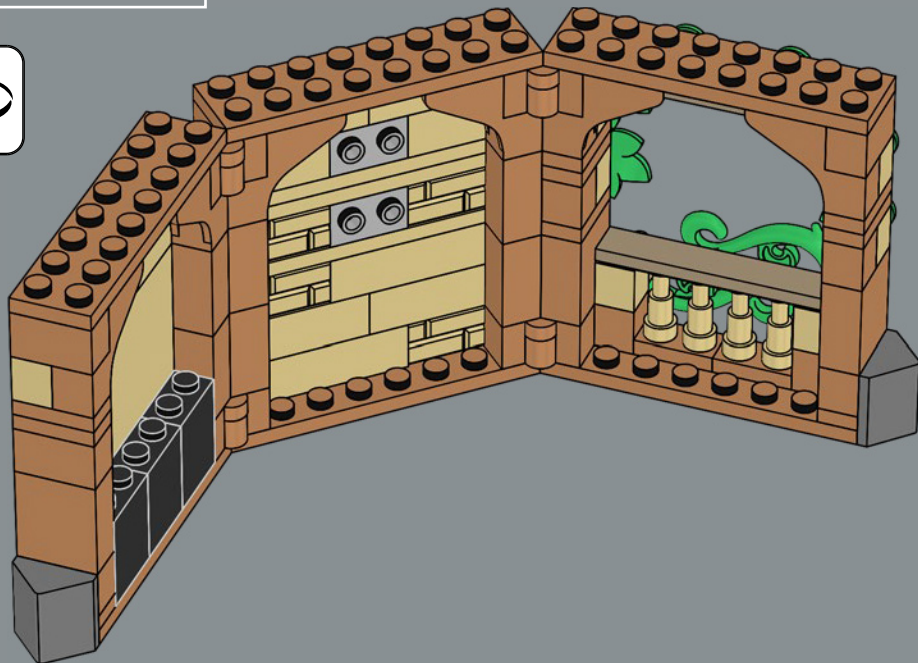

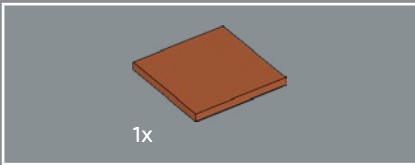

64

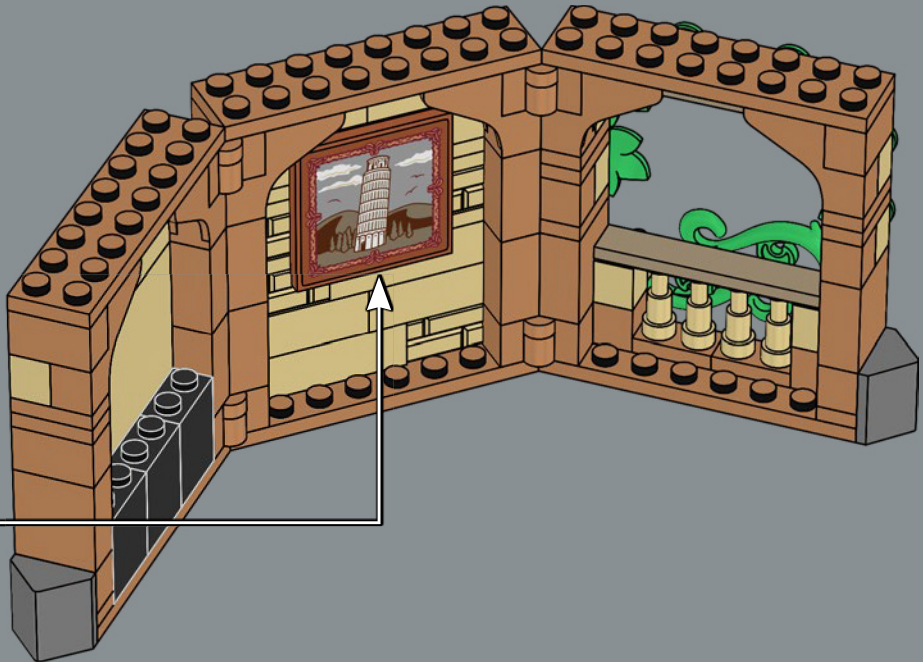
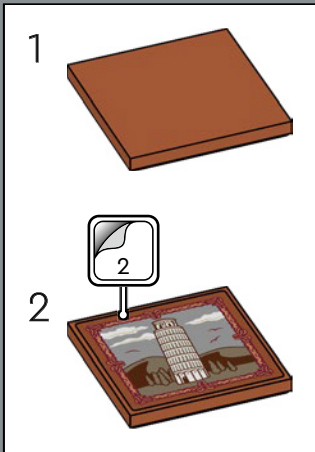

65



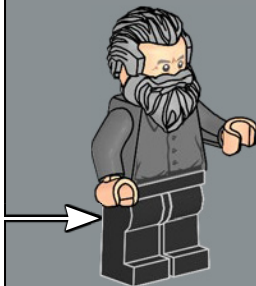
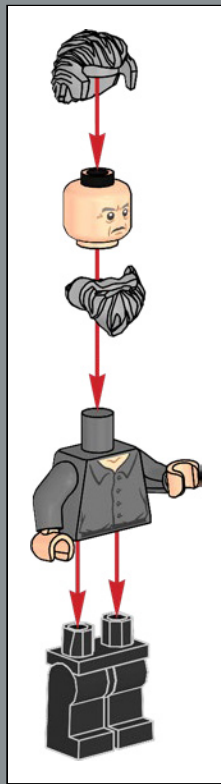

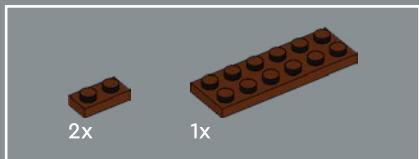

66

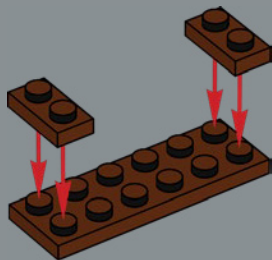

67

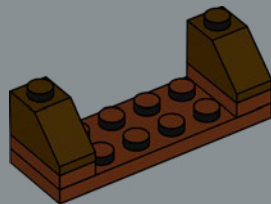



68

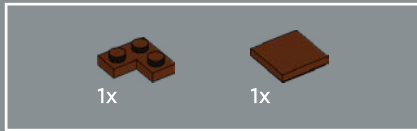
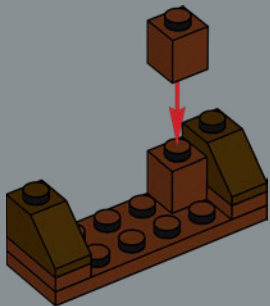

69

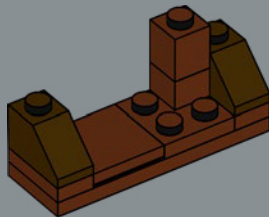

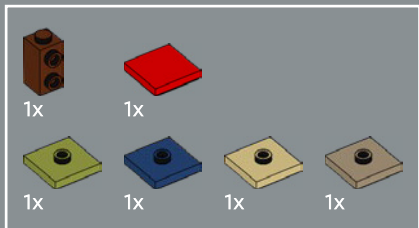

70

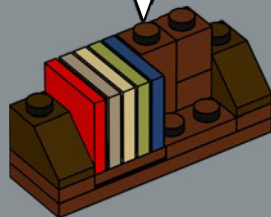
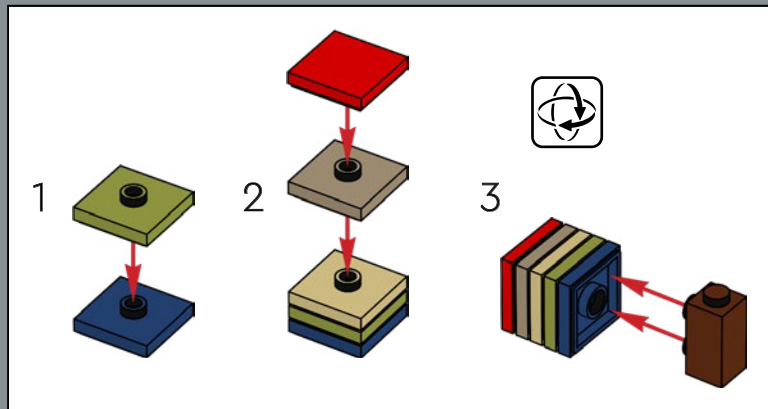

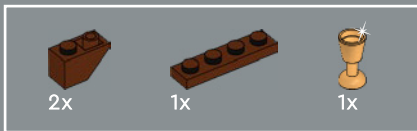

71

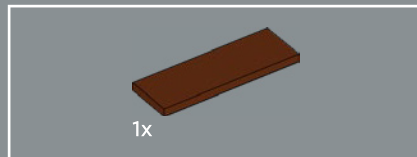

72



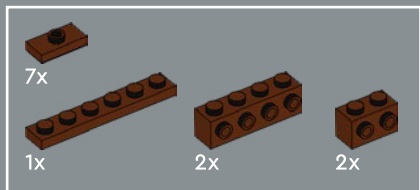

73

1

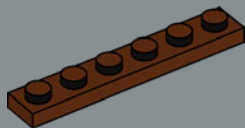

2

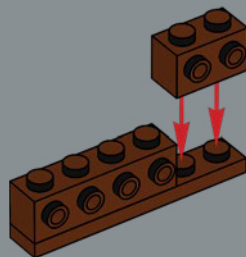

3

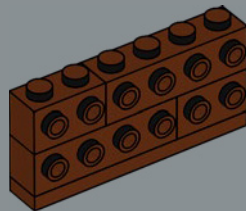

4

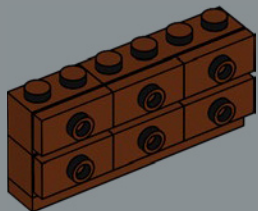

5

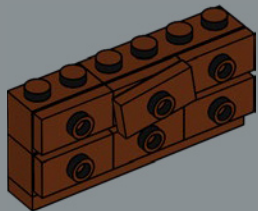

74

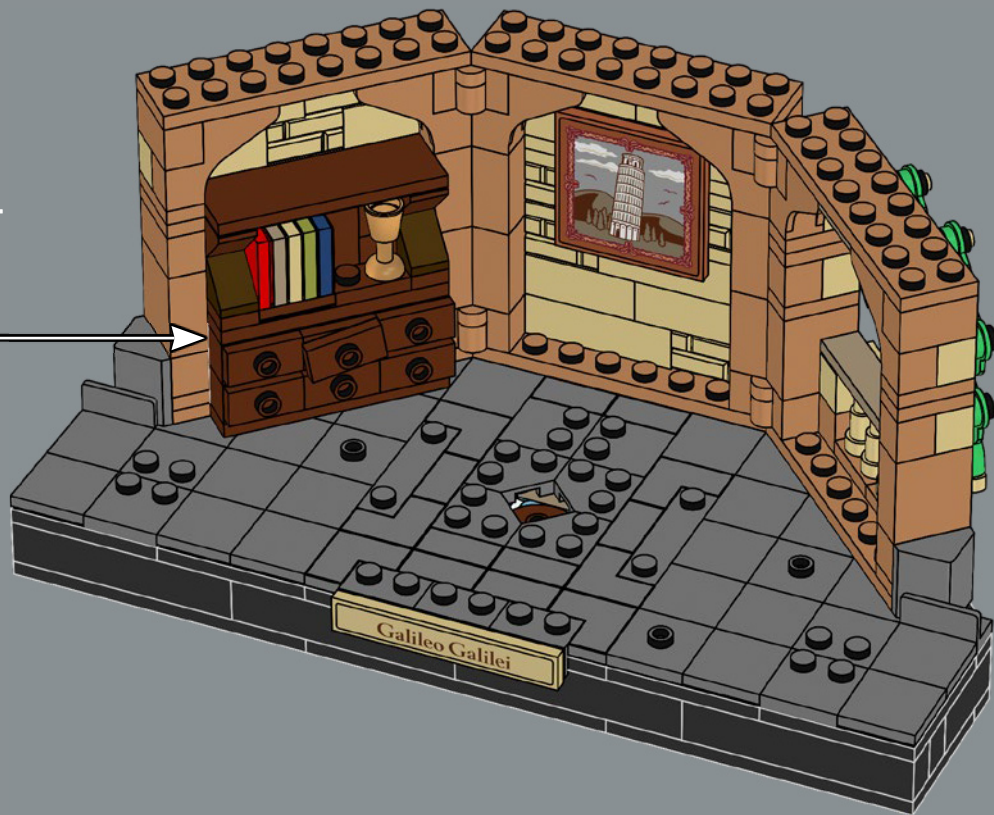

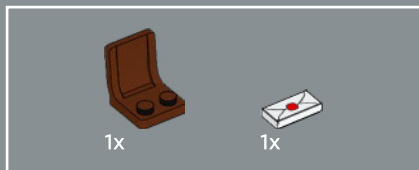

75

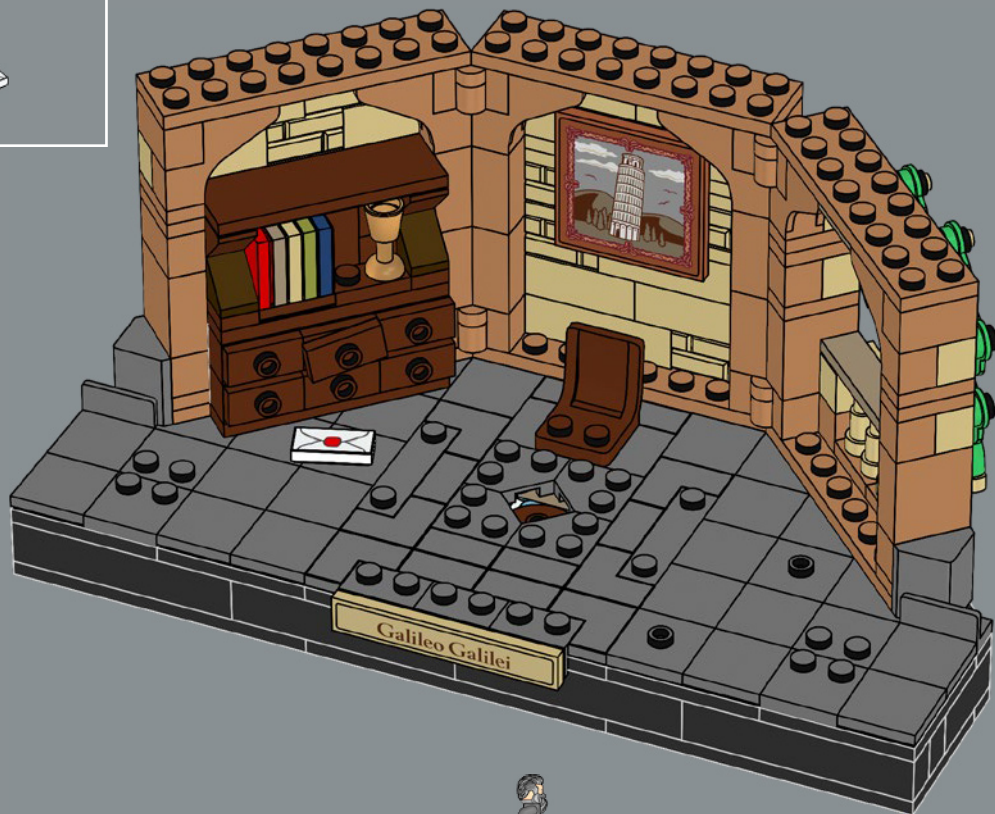

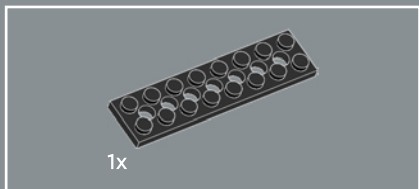

1x

76

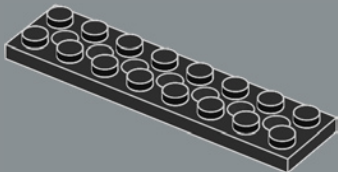

2x

77

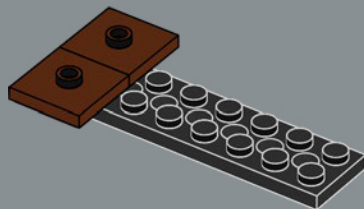

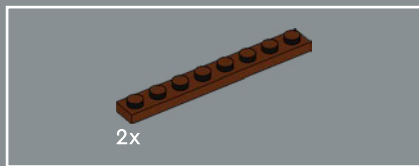

78

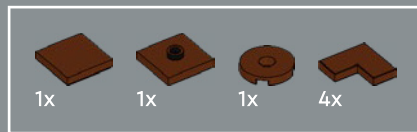
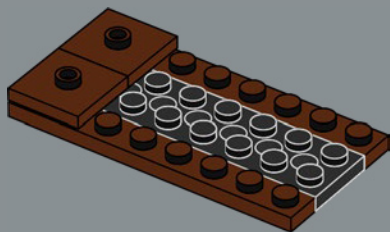

79

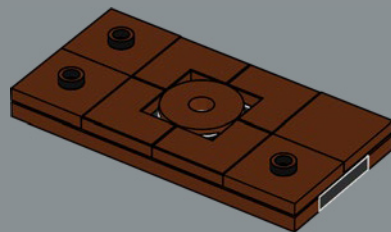

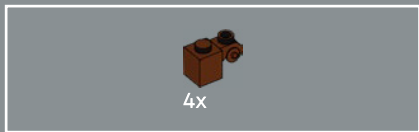

80

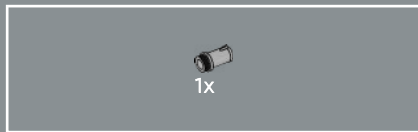
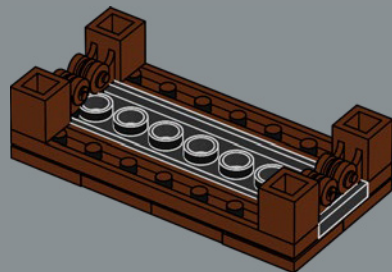

81

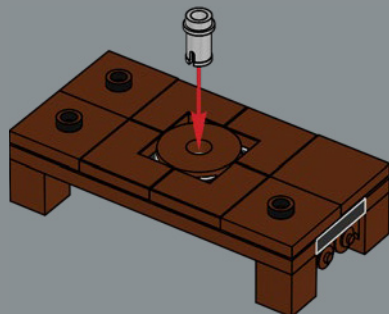

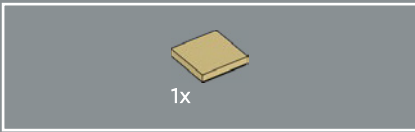

82

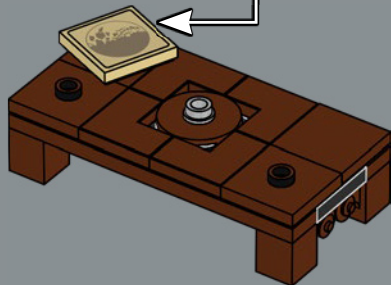
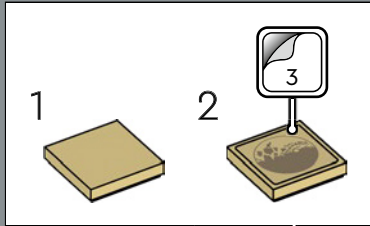

83

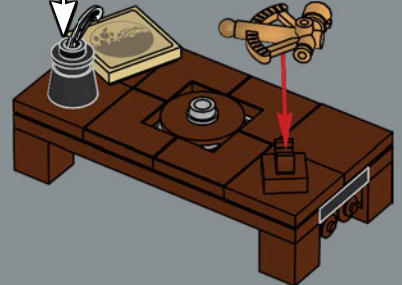
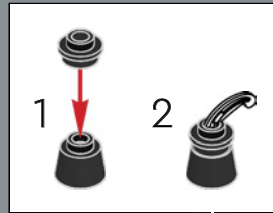

84

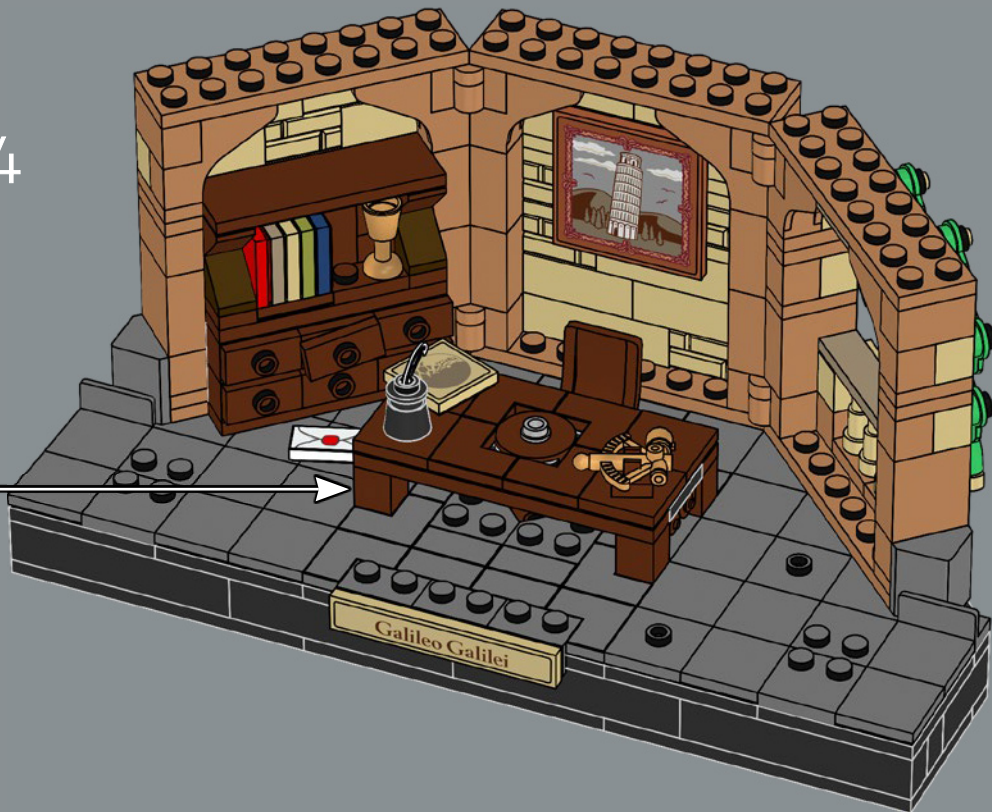



85

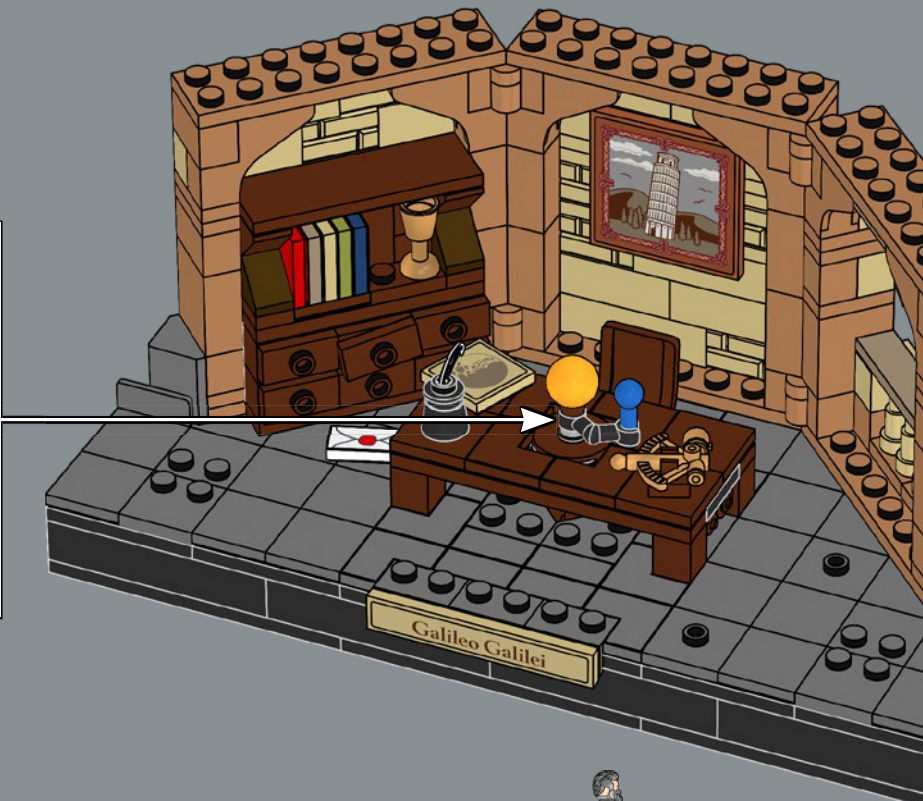
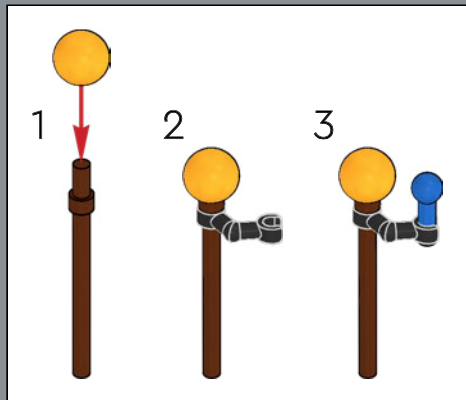

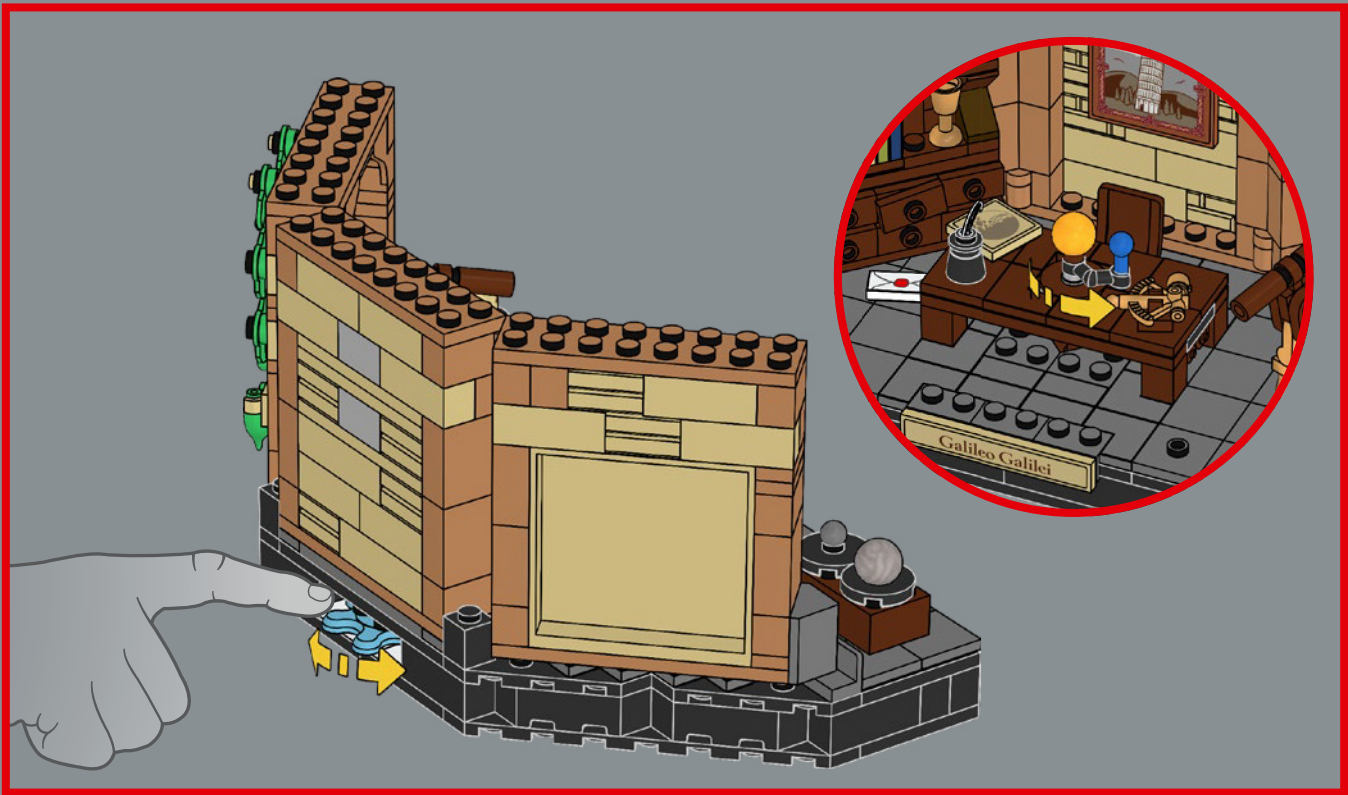



86

1

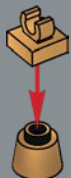

2

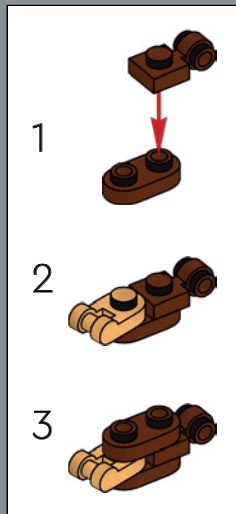

3

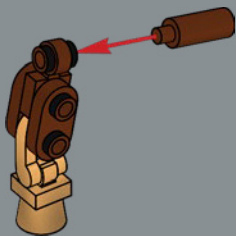

4

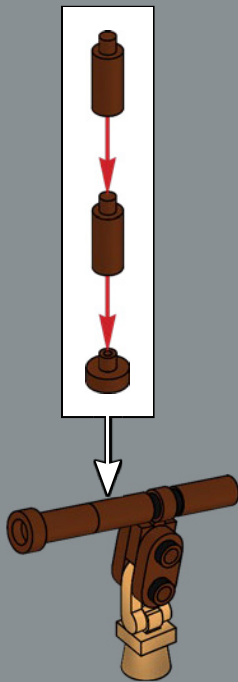



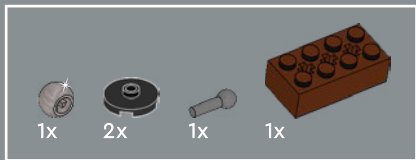

87

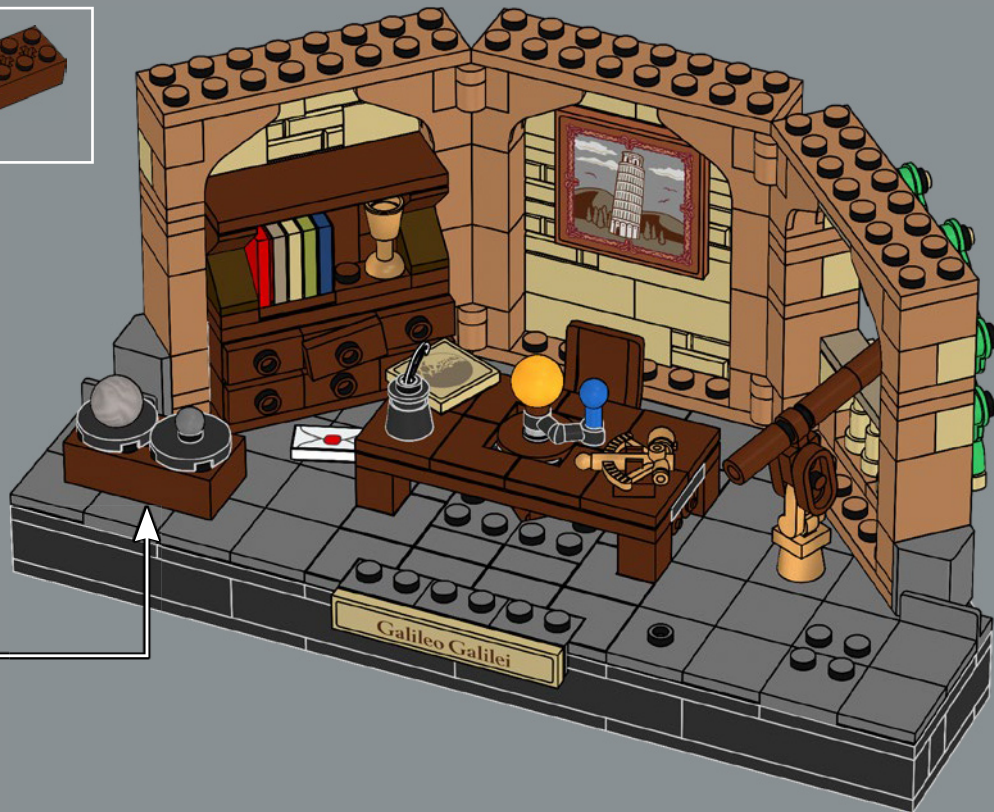
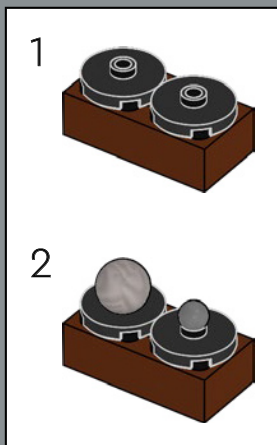



88

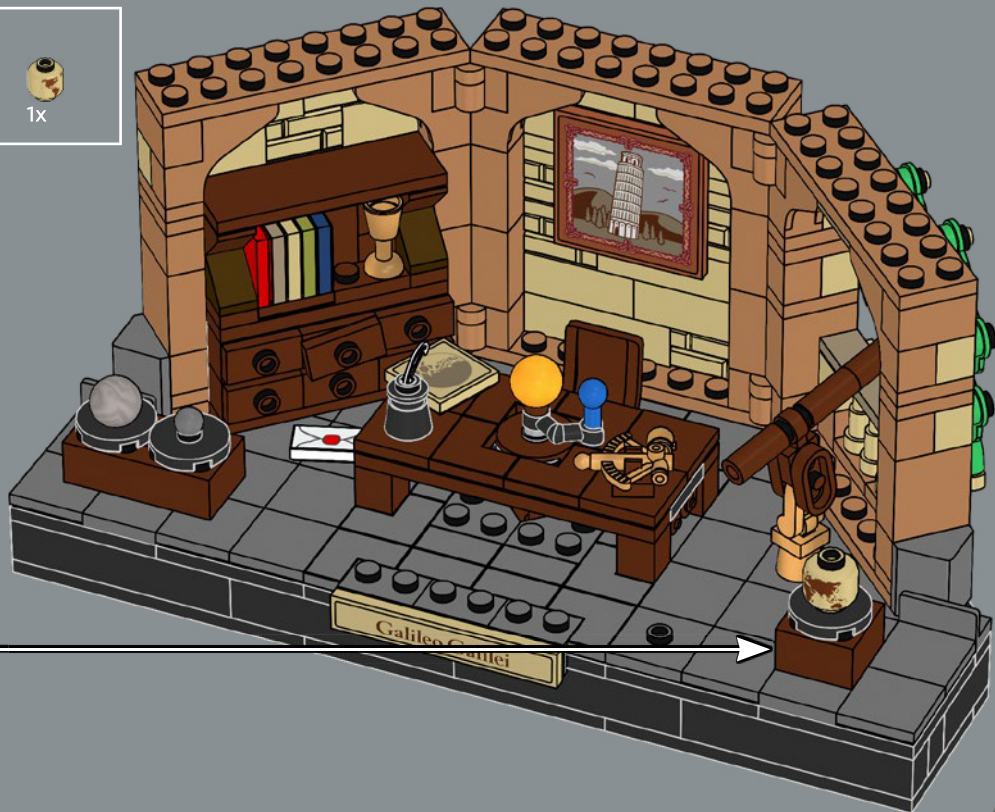
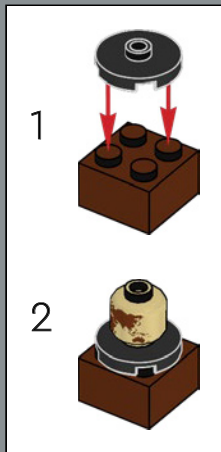



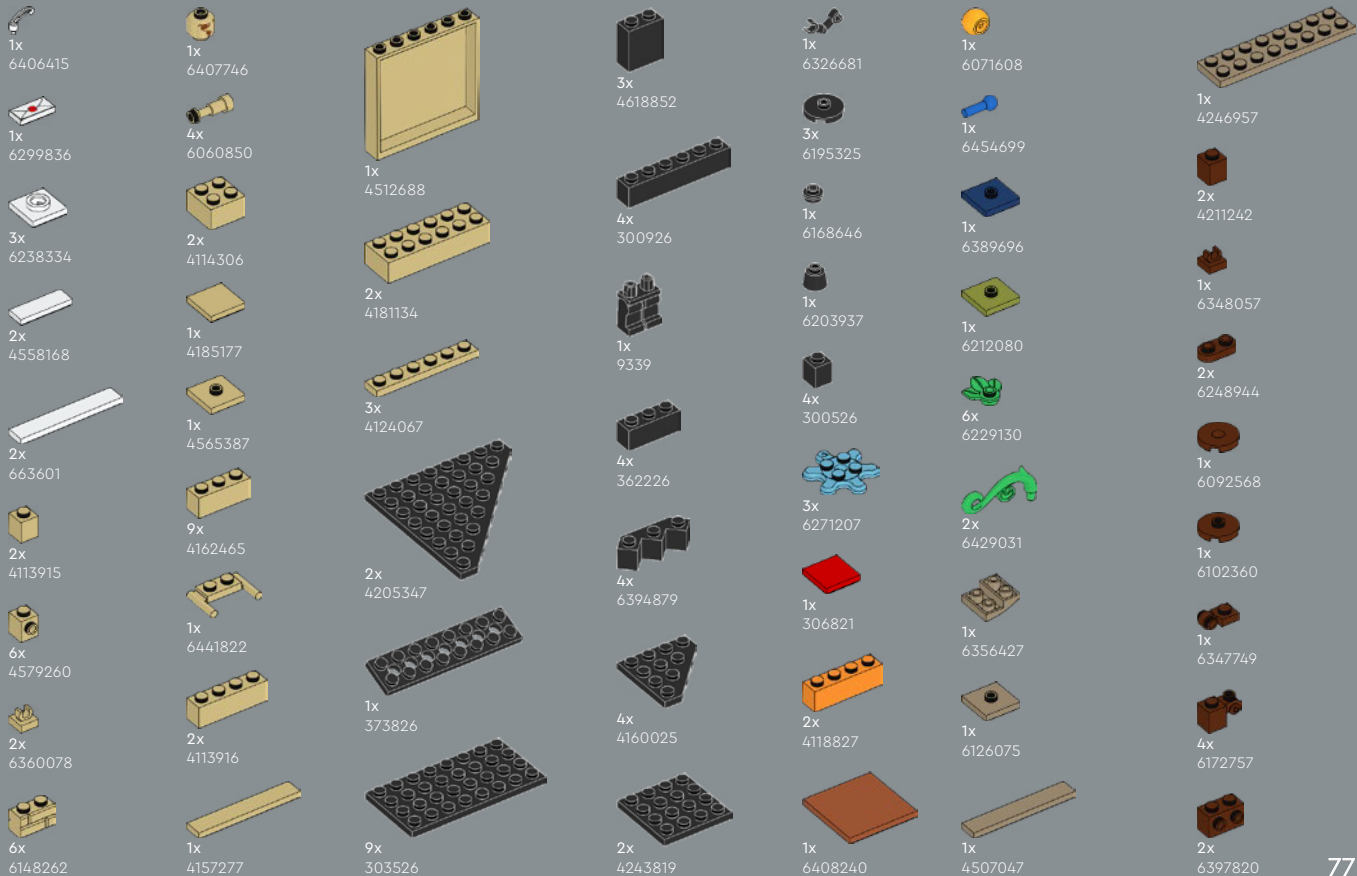



2x
4211222



1x
4211206



2x
4211189



2x
6153594



4x
6221608



2x
4211150



1x
4211257



2x
4271949



1x
4211210



3x
4565394



7x
6092590



3x
6422088



1x
6186673



1x
6201911



1x
4211190



1x
6365882



1x
6170468



1x
4221590



1x
4211247



1x
6326103



2x
4216945



1x
6227597



3x
4569382



4x
6344798



4x
6102967



6x
4568955

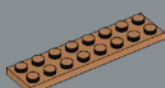

6x
6226644



5x
6057986



9x
6401021



11x
6218360



2x
6411587



12x
6247784



3x
6126083



1x
6347849



2x
6257592



1x
4211002



1x
6364352



8x
4211052



4x
6164073



2x
6146225



3x
6214341



2x
6232193



6x
6309059



23x
4211055



2x
6015344



1x
4211483



1x
6375517



1x
6123037



2x
4518557



1x
6262138



1x
6212377



1x
6323378



1x
4505990



1x
6173139



1x
6082975



 [LEGO.com/service](https://www.lego.com/service)



YOU COULD WIN



YOU COULD WIN

Your feedback will help shape the future development of this product series.

Visit:

DU KÖNNTEST GEWINNEN

Dein Feedback trägt zur Weiterentwicklung dieser Produktreihe bei.

Geh auf:

VOUS POURRIEZ GAGNER

Vos commentaires nous aideront à concevoir les futurs produits de cette gamme.

Visitez :

POTRESTI VINCERE TU

La tua opinione ci aiuterà a migliorare la creazione futura di questa linea di prodotti.

Visita:

PUEDES GANAR

Tu opinión contribuirá al futuro de esta serie de productos.

Visita:

轻松获奖

您的反馈将有助于我们在今后改进本产品系列。

请访问：

LEGO.com/productfeedback

You also have the chance to win a LEGO® set.

Terms and conditions apply.*

Außerdem hast du die Chance, ein LEGO® Set zu gewinnen.

Es gelten die Teilnahmebedingungen.*

Vous pourriez également gagner un ensemble LEGO®.

Des conditions s'appliquent.*

Hai anche la possibilità di vincere un set LEGO®.

Termini e condizioni sono applicabili.*

También tienes la oportunidad de ganar un set LEGO®.

Aplican términos y condiciones.*

您还有机会赢取乐高®套装。

条款和条件适用。*

*LEGO.com/productfeedback-terms

IDEASⁱ

LEGO and the LEGO logo are trademarks of the LEGO Group.
©2023 The LEGO Group. 6475494